



Industrial DC/DC CONVERTER MGDI-75 Wide Input : 75W POWER

Industrial Grade ■

**4:1 Wide Input
Single Output
Metallic case - 1 500 VDC Isolation**



- Wide input range 9-36 Vdc, 18-75 Vdc
- Industry standard quarter brick package
- Power up to 75 W
- High efficiency (typ. 85%-88%)
- Soft start
- Galvanic isolation 1 500 VDC
- Integrated LC EMI filter
- Synchronizable
- Under voltage lock-out
- Overvoltage protection
- Current limitation protection
- Overtemperature protection
- No optocoupler for high reliability
- Leaded process

1-General

The MGDI-75 wide input series is a full family of DC/DC power modules designed for use in distributed power architecture where variable input voltage and transient are prevalent making them ideal particularly for transportation, railways or high-end industrial applications. These modules use a high frequency fixed switching topology at 420KHz providing excellent reliability, low noise characteristics and high power density. Standard models are available with wide input voltage range of 9-36 and 18-75 volts. The serie includes single output voltage choices of 3.3, 5, 12, 15 and 24 volts.

The MGDI-75 series include synchronization, trim and sense functions.

The synchronization function allows to synchronize more than one converter to one frequency or an external source frequency.

All the modules are designed with LC network filters to minimize reflected input current ripple and output voltage ripple.

The modules have totally independant security functions including input undervoltage lock-out, output overvoltage protection, output current limitation protection, and temperature protection. Additionnally a soft-start function allows current limitation and eliminates inrush current during start-up.

The design has been carried out with surface mount components, planar transformer and is manufactured in a fully automated process to guarantee high quality. The modules are potted with a bi-component thermal conductive compound and used an insulated metallic substrat to ensure optimum power dissipation under harsh environmental conditions.

5

2-Product Selection

Single output model : MGDSI - 75 - - / -

Input Voltage Range	
Permanent	Transient
H : 9-36 VDC	40 VDC/100 ms
O : 18-75 VDC	80 VDC/100 ms

Output
B : 3.3 VDC
C : 5 VDC
E : 12 VDC
F : 15 VDC
I : 24 VDC

Suffix :
-L : leaded process

2- Product Selection (continued)

Input range	Output	Current	Reference	Options	Suffix
9-36 VDC	3.3 VDC	15 A	MGDSI-75-H-B	/	-L
9-36 VDC	5 VDC	15 A	MGDSI-75-H-C	/	-L
9-36 VDC	12 VDC	6,25 A	MGDSI-75-H-E	/	-L
9-36 VDC	15 VDC	5 A	MGDSI-75-H-F	/	-L
9-36 VDC	24 VDC	3,125 A	MGDSI-75-H-I	/	-L
18-75 VDC	3.3 VDC	15 A	MGDSI-75-O-B	/	-L
18-75 VDC	5 VDC	15 A	MGDSI-75-O-C	/	-L
18-75 VDC	12 VDC	6,25 A	MGDSI-75-O-E	/	-L
18-75 VDC	15 VDC	5 A	MGDSI-75-O-F	/	-L
18-75 VDC	24 VDC	3,125 A	MGDSI-75-O-I	/	-L

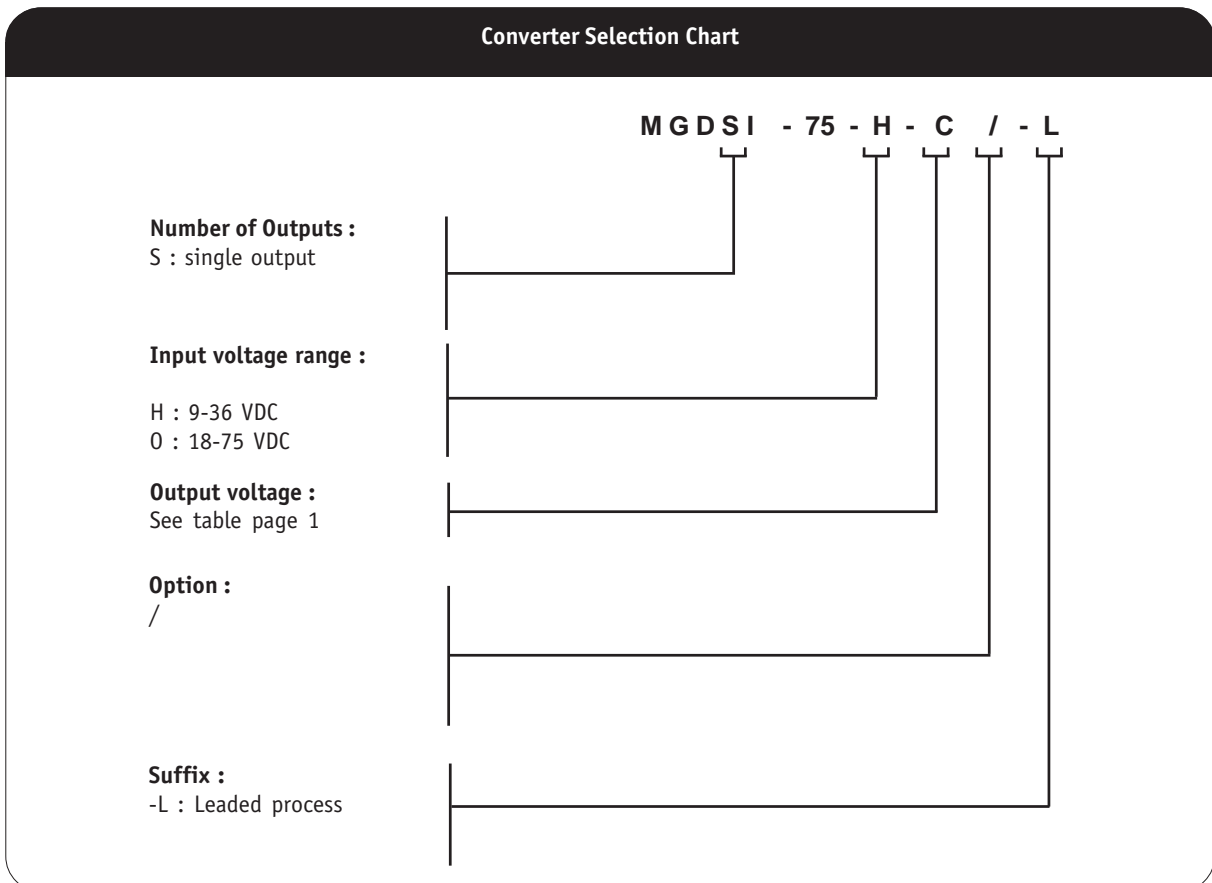

3- Electrical Specifications

Data are valid at +25°C, unless otherwise specified.

Parameter	Conditions	Limit or typical	Units	Single Output MGDSI-75	
				75 - H	75 - 0
Input					
Nominal input voltage	Full temperature range	Nominal	VDC	24	48
Permanent input voltage range (Ui)	Full temperature range	Min. - Max.	VDC	9 - 36	18 - 75
Transient input voltage	Full load	Maximum	VDC/S	40/0,1	80/0,1
Undervoltage lock-out (UVLO)		Typical	VDC	8,5	17
Start up time	Ui nominal Nominal output Full load : resistive	Maximum	ms	30	30
Reflected ripple current	Ui nominal, full load BW = 20MHz	Maximum	mApp	500	500
Input current in short circuit mode (Average)	Ui nominal Short-circuit	Typical	A	1	0,2
No load input current	Ui nominal No load	Maximum	mA	30	30
Input current in inhibit mode	Ui nominal Inhibit	Maximum	mA	10	10
Output					
Output voltage *	Ui min. to max.	Nominal	VDC	3,3	3,3
		Nominal	VDC	5	5
		Nominal	VDC	12	12
		Nominal	VDC	15	15
		Nominal	VDC	24	24
Set Point accuracy *	Ambient temperature : +25°C Ui nominal, 75% load	Maximum	%	+/- 2	+/- 2
Output power	Ui min. to max.	Maximum	W	50 to 75	50 to 75
Output current					
3,3V output		Maximum	A	15	15
5V output	Full temperature range	Maximum	A	15	15
12V output	Ui min. to max.	Maximum	A	6,25	6,25
15V output		Maximum	A	5	5
24V output		Maximum	A	3,125	3,125
Ripple output voltage					
3,3V and 5V output	Ui nominal	Typical	mVpp	50	50
12V output	Full load	Typical	mVpp	100	100
15V output	BW = 20MHz	Typical	mVpp	150	150
24V output		Typical	mVpp	250	250
Output regulation * (Line + load + thermal)	Ui min. to max. 0% to full load	Maximum	%	+/- 1	+/- 1
Output Voltage Trim	As function of output voltage	Minimum	%	90 **	90 **
		Maximum	%	110	110
Efficiency	Ui nominal Full load	Typical	%	85	88

Note * : These performances are measured with the sense line connected..

Note ** : It is recommended to mount the converter on a heatsink for this test

Note *** : The ripple output voltage is the periodic AC component imposed on the output voltage, an aperiodic and random component (noise) has also to be considered. It is recommended to add 4 external decoupling capacitors (typically 10nF) connected between inputs and case and between outputs and case. These capacitance should be layed-out as close as possible from the converter.

4- Switching Frequency

Parameter	Conditions	Limit or typical	Specifications
Switching frequency	Full temperature range Ui min. to max. No load to full load	Nominal, fixed	420 KHz

5- Isolation

Parameter	Conditions	Limit or typical	Specifications
Electric strength test voltage	Input to output	Minimum	1 500 VDC / 1 min
	Input to case	Minimum	1 500 VDC / 1 min
	Output to case	Minimum	1 500 VDC / 1 min
Isolation resistance	500 VDC	Minimum	100 MOhm

6- Protection Functions

Characteristics	Protection Device	Recovery	Limit or typical	Specifications
Input undervoltage lock-out (UVLO)	Turn-on, turn-off circuit with hysteresis cycle	Automatic recovery	Turn-on nominal Turn-off nominal	see section 4
Output current limitation protection (OCP)	Straight line current limitation	Automatic recovery	Nominal	120% of output current
Output overvoltage protection (OVP)	Overvoltage protection device with latch-up	Automatic recovery	Nominal	120% of output voltage
Over temperature protection (OTP)	Thermal device with hysteresis cycle	Automatic recovery	Nominal	115°C

7- Reliability Data

Characteristics	Conditions	Temperature	Specifications
Mean Time Between Failure (MTBF) According to MIL-HDBK-217F	Ground fixed (Gf)	Case at 40°C Case at 70°C	765 000 Hrs 250 000 Hrs
	Ground mobile (Gm)	Case at 40°C Case at 70°C	310 000 Hrs 140 000 Hrs
Mean Time Between Failure (MTBF) According to IEC-62380-TR	Railway, Payphone	Ambient at 25°C 100% time on	220 000 Hrs

8- Electromagnetic Interference

Electromagnetic interference requirements according to EN55022 class A and class B can be easily achieved as indicated in the following table :

Electromagnetic Interference according to EN55022		
Conducted noise emission	Configuration	With 4 common mode capacitors $C_c = 10\text{nF}$ and external filter
	Models	Class A
Radiated noise emission	Configuration	With 4 common mode capacitors $C_c = 10\text{ nF}$ and external filter
	Models	Class B

8-1 Module Compliance with EN55022 class A/class B Standard

Electromagnetic interference requirements according to EN55022 class A or class B can be easily achieved by adding an external common mode noise capacitance ($C_c = 10\text{nF}/\text{rated voltage}$ depending on isolation

requirement) and an external filter. The common mode noise capacitance C_c should be layed-out as close as possible from the DC/DC converter. Please consult factory for details.

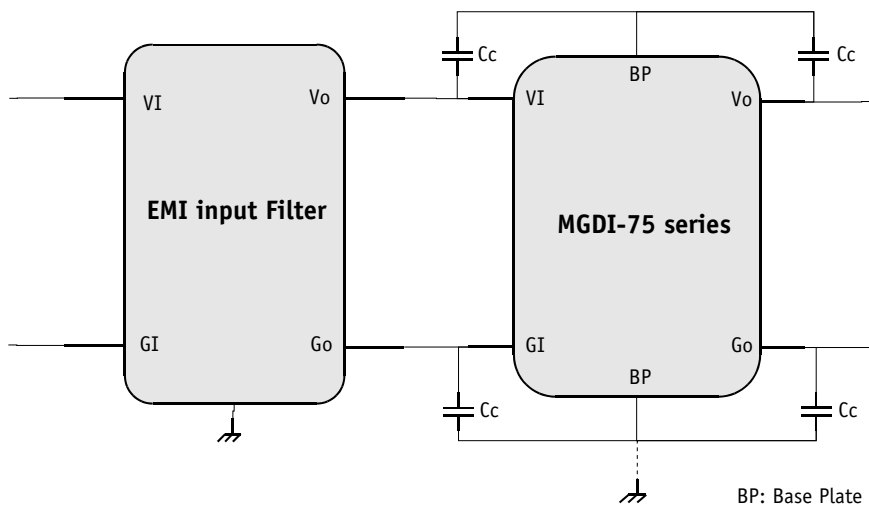

* Note : Value of common mode noise capacitance depends on isolation requirements (typically 10nF/1500V or 10nF/3000V). In case of dielectric strength test in AC mode, adapt the capacitance value in order to be compatible with maximum admissible leakage current.

9- Thermal Characteristics

Characteristics	Conditions	Limit or typical	Performances
Operating ambient temperature range at full load	Ambient temperature *	Minimum Maximum	- 40°C see below
Baseplate temperature	Base plate temperature	Minimum Maximum	- 40°C + 100°C
Storage temperature range	Non fonctionning	Minimum Maximum	- 40°C + 105°C
Thermal resistance	Baseplate to ambient Rth(b-a) free air	Typical	11°C/W

Note * : The upper temperature range depends on configuration, the user must ensure a max. baseplate temperature of + 105°C.

The following discussion will help designer to determine the thermal characteristics and the operating temperature.

The MGDI-75 series maximum **baseplate** temperature at full load must not exceed 100°C. Heat can be removed from the baseplate via three basic mechanisms :

- Radiation transfert : radiation is counting for less than 5% of total heat transfert in majority of case, for this reason the presence of radiant cooling is used as a safety margin and is not considered.
- Conduction transfert : in most of the applications, heat will be conducted from the baseplate into an attached heatsink or heat conducting member; heat is conducted thru the interface.
- Convection transfert : convecting heat transfer into air refers to still air or forced air cooling.

In majority of the applications, heat will be removed from the baseplate either with :

- heatsink,
- forced air cooling,
- both heatsink and forced air cooling.

To calculate a maximum admissible ambient temperature the following method can be used.

Knowing the maximum baseplate temperature $T_{base} = 100^\circ\text{C}$ of the module, the power used P_{out} and the efficiency η :

- determine the power dissipated by the module P_{diss} that should be evacuated :

$$P_{diss} = P_{out} \left(\frac{1}{\eta} - 1 \right) \quad (A)$$

- determine the maximum ambient temperature :

$$T_a = 100^\circ\text{C} - R_{th}(b-a) \times P_{diss} \quad (B)$$

where **Rth(b-a)** is the thermal resistance from the baseplate to ambient.

This thermal Rth(b-a) resistance is the summ of :

- **the thermal resistance of baseplate to heatsink (Rth(b-h))**. The interface between baseplate and heatsink can be nothing or a conducting member, a thermal compound, a thermal pad.... The value of Rth(b-h) can range from 0.4°C/W for no interface down to 0.1°C/W for a thermal conductive member interface.
- **the thermal resistance of heatsink to ambient air (Rth(h-a))**, which is depending of air flow and given by heatsink supplier.

The table hereafter gives some example of thermal resistance for different heat transfert configurations.

Heat transfert	Thermal resistance heatsink to air Rth(h-a)	Thermal resistance baseplate to heatsink Rth(b-h)	Global resistance
Free air cooling only	No Heatsink baseplate only : 11°C/W	No need of thermal pad	11°C/W
	Heatsink Thermaflo 424800B0000 : 3,5°C/W	Bergquist Silpad* : 0,21°C/W	3,71°C/W
Forced air cooling 200 LFM	No Heatsink baseplate only : 6,9°C/W	No need of thermal pad	6,9°C/W
	Heatsink Thermaflo 424800B0000 : 2,8°C/W	Bergquist Silpad* : 0,21°C/W	3,01°C/W
Forced air cooling 400 LFM	No Heatsink baseplate only : 4,8°C/W	No need of thermal pad	4,8°C/W
	Heatsink Thermaflo 424800B0000 : 1,8°C/W	Bergquist Silpad* : 0,21°C/W	2,01°C/W
Forced air cooling 1000 LFM	No Heatsink baseplate only : 2,8°C/W	No need of thermal pad	2,8°C/W
	Heatsink Thermaflo 424800B0000 : 1°C/W	Bergquist Silpad* : 0,21°C/W	1,21°C/W

Radian and Thermaflo are heatsink manufacturers. «Silpad»[®] is a registered trademark of Bergquist.

Note* : Silpad performance are for Silpad 400 with pressure conditions of 50 Psi. Surface of MGDS-75 series is 3,3 inch².

9- Thermal Characteristics (continued) : Heatsink Mounting

To mount properly the module to heatsink, some important recommendations need to be taken into account in order to avoid overstressing conditions that might lead to premature failures.

The module case is built with a copper IMS (isolated metallic substrate) crimped on an aluminum frame that provides case rigidity. The IMS surface is the module base plate that need to be reported to heat sink to achieve proper cooling. If for some reasons like poor module report, the IMS base plate is subject to mechanical overstress, module's electrical characteristics may be definitely affected.

A typical example of damageable report is the use of thick thermal interface with usual screwing torque applied on mounting screws. This combination causes a high pressure on baseplate center due to thermal interface material compression. The final consequence is a slight IMS bending that can conduct for the module to fail high voltage isolation leading to heavy electrical damage on internal circuit.

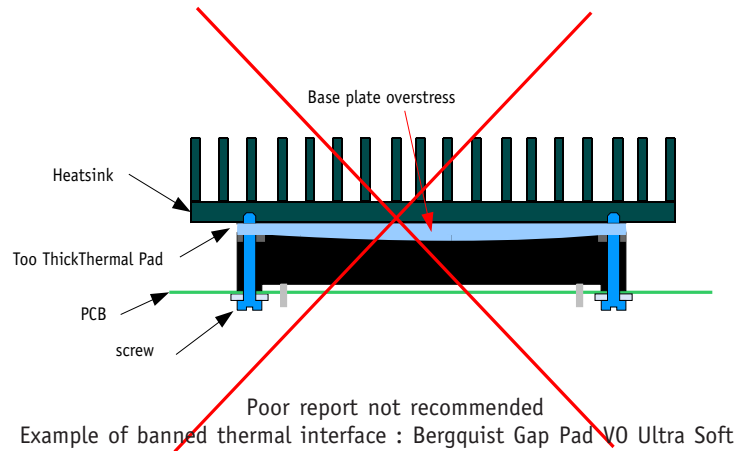

The good practice is to respect the 4 following recommendations:

- do not exceed recommended screwing torque of 0,7 N.m (6 lbs.in)
 - prefer thin thermal pad with thickness lower than 0,34 mm (0.015").
- GAIA Converter recommends to use thin thermal pads instead of thermal compound like grease.
- take care to reflow module leads only when all assembly operations are completed.
 - do not report module on surfaces with poor flatness characteristics. GAIA Converter recommends not to overflow 0,1mm/m for the surface flatness.

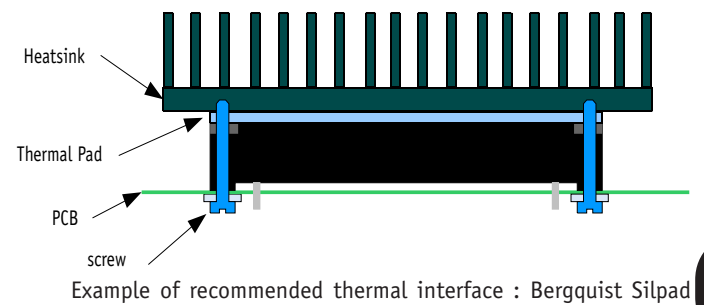

5

Gaia converter suggests to follow the procedure hereunder for the mechanical assembly procedure in order to avoid any stress on the pins of the converters. It is good practice to be sure to mount the converters first mechanically, then solder the units in place.

1. Choice of the thermal gap pad : its shape must be the same as the module. The dimensions of the gap pad can be a little larger than the module.
2. Screw the converter to the heatsink and/or to the board. The four screws have to be screwed in a "X" sequence.
 - Lightly finger-tighten all screws and run several «X» sequences before achieving final torque to get homogeneous tightening.
 - Torque screws from 0,35 N.m (3 lbs.in) to 0,7 N.m (6 lbs.in).
3. Screw the heatsink to the board.
4. Solder the pins of the converters on the board. This sequence avoids mechanical stresses on the converters that could lead to stress internal components or assemblies and cause their failures.

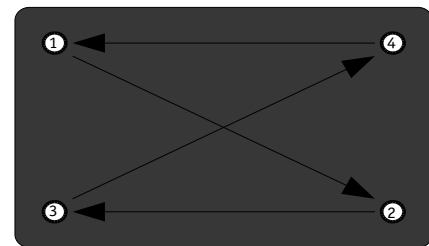

10- Environmental Qualifications

The modules have been subjected to the following environmental qualifications.

Characteristics	Conditions	Severity	Test procedure
Climatic Qualifications			
Life at high temperature	Duration Temperature Status of unit	1 000 Hrs 95°C case unit operating	IEC 68-2-2
Humidity steady	Damp heat Temperature Duration Status of unit	93 % relative humidity 40°C 56 days unit not operating	IEC 68-2-3 Test Ca
Temperature cycling	Number of cycles Temperature change Transfert time Steady state time Status of unit	200 -40°C / +71°C 40 min. 20 min. unit not operating	IEC 68-2-14 Test N
Temperature shock	Number of shocks Temperature change Transfert time Steady state time Status of unit	50 -40°C / +105°C 10 sec. 20 min. unit not operating	IEC 68-2-14 Test Na
Mechanical Qualifications			
Vibration (Sinusoidal)	Number of cycles Frequency : amplitude Frequency : acceleration Amplitude /acceleration Duration Status of unit	10 cycles in each axis 10 to 60 Hz / 0.7 mm 60 to 2000 Hz / 10 g 0.7 mm/10 g 2h 30 min. per axis unit not operating	IEC 68-2-6 Test Fc
Shock (Half sinus)	Number of shocks Peak acceleration Duration Shock form Status of unit	3 shocks in each axis 100 g 6 ms 1/2 sinusoidal unit not operating	IEC 68-2-27 Test Ea
Bump (Half sinus)	Number of bumps Peak acceleration Duration Status of unit	2 000 bumps in each axis 25 g 6 ms unit not operating	IEC 68-2-29 Test Eb
Electrical Immunity Qualifications			
Electrical discharge susceptibility	Number of discharges Air discharge level Contact discharge level Air discharge level Contact discharge level	10 positive & 10 negative discharges 4 kV : sanction A 2 Kk : sanction A 8 Kk : sanction B 4 kV : sanction B	EN55082-2 with : EN61000-4-2 IEC 801-2
Electrical field susceptibility	Antenna position Electromagnetic field Wave form signal Frequency range	at 1 m 10 V/m AM 80%, 1 kHz 26 MHz to 1 GHz	EN55082-2 with : EN61000-4-3 IEC801-3
Electrical fast transient susceptibility	Burst form Wave form signal Impedance Level 1 Level 3	5/50 ns 5 kHz with 15 ms burst duration period 300 ms 50 Ohm 0,5 kV : sanction A 2 kV : sanction B	EN55082-2 with : EN61000-4-4 IEC801-4
Surge Susceptibility	Surge form Impedance Level 4	1,2/50 µs 2 Ohm 4 kV : with transient protection (see section surge)	EN61000-4-5 EN50155

11- Description of Protections

The MGDI-75 series include 3 types of protection devices that are powered and controlled by a fully independent side power stage.

11-1 Input Undervoltage Lockout (UVLO)

11-1-1 Undervoltage Lockout (UVLO)

An undervoltage protection will inhibit the module when input voltage drops below the lockout turn-off threshold (see section 4 for value) and restores to normal operation automatically when the input voltage rises the lockout turn-on threshold.

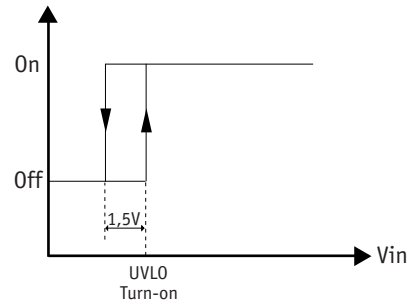

11-2 Output Over Current Protection (OCP)

The MGDI-75 Series incorporates a current limit and protection circuit. When the output current reaches 110%-140% of its full-rated current ($I_{current\ limit}$), the output voltage falls and output current falls along the line as described in the figure herein. The module restart automatically to normal operation when overcurrent is removed.

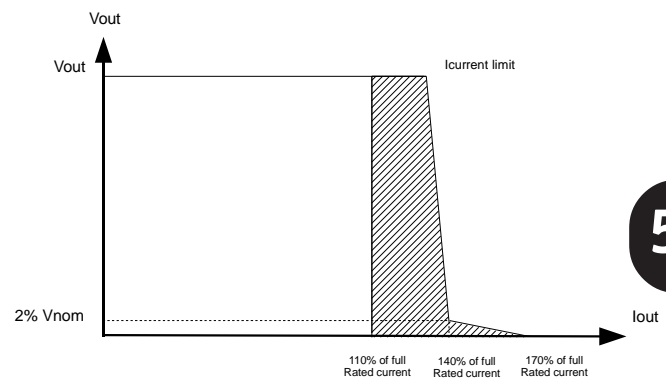

11-3 Output Overvoltage Protection (OVP)

Each circuit has an internal overvoltage protection circuit that monitors the voltage across the output power terminals. It is designed to turn the converter off at 120% (+/-5%) of output voltage. Once in OVP protection, the module will restart automatically when overvoltage is removed.

11-4 Over Temperature Protection (OTP)

A thermal protection device adjusted at 115°C (+/-5%) internal temperature with 10°C hysteresis cycle will inhibit the module as long as the overheat is present and restores to normal operation automatically when overheat is removed. The efficiency of the OTP function is warranty with the module mounted on a heatsink.

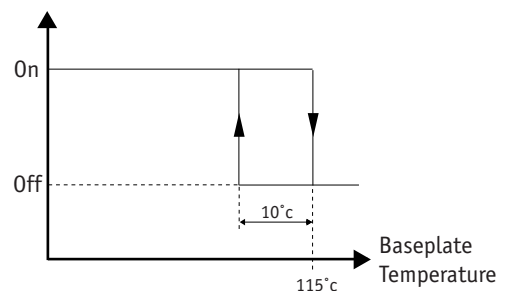

12- Description of Functions

12-1 Trim Function

The output voltage V_o may be trimmed in a range of 90%/110% of the nominal output voltage via a single external trimpot or fixed resistor.

Trim Up Function

Do not attempt to trim the module higher than 110% of nominal output voltage as the overvoltage protection may occur.

Also do not exceed the maximum rated output power when the module is trimmed up.

The trim up resistor must be connected to S+ pin.

The trim up resistance must be calculated with the following formula :

$$R_u = \frac{R_1 (V_o - V_{ref}) V_{0nom}}{(V_o - V_{0nom}) V_{ref}} - R_1 - R_2$$

Trim Down Function

Do not trim down more than -10% of nominal output voltage.

The available output power is reduced by the same percentage that output voltage is trimmed down.

The trim down resistor must be connected to S- pin.

The trim down resistance must be calculated with the following formula :

$$R_d = \frac{(R_2 + R_1) V_o - R_2 V_{0nom}}{V_{0nom} - V_o}$$

Trim via a voltage

The output voltage is given by the following formula :

$$V_o = 1 + \frac{R_1}{(R_1 + R_2)} \frac{(V_{trim} - 1)}{V_{ref}}$$

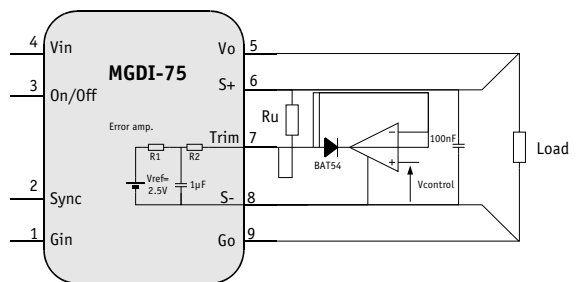
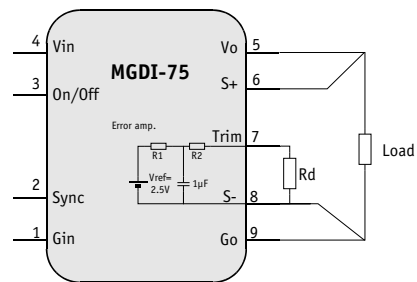
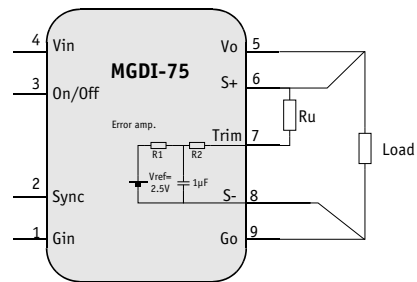

Parameter	Unit	Min.	Typ.	Max.
Trim reference	Vdc	2,45	2,5	2,55
Resistor R1	Ohm	/	3 600 for H input 3 900 for 0 input	/
Resistor R2	Ohm	/	270	/
Trim capacitor	µF	/	1	/

12- Description of Functions (continued)

12-2 Sense Function

If the load is separated from the output by any line length, some of these performance characteristics will be degraded at the load terminals by an amount proportional to the impedance of the load leads. Sense connections enable to compensate the line drop at a maximum of 10% of output voltage. The overvoltage protection will be activated if remote sense tries to boost output voltage above 110% of nominal output voltage. Connection is described in figure herein.

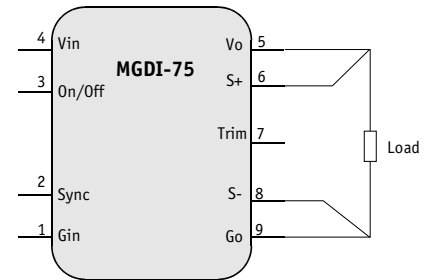

12-3 On/Off Function

The control pin 3 (On/Off) can be used for applications requiring On/Off operation. This may be done with an open collector transistor, a switch, a relay or an optocoupler. Several converters may be disabled with a single switch by connecting all

On/Off pins together.

- The converter is disabled by pulling low the pin 3.
- No connection or high impedance on pin 4 enables the converter.

By releasing the On/Off function, the converter will restart within the start up time specifications given in table section 3. For further details please consult "Logic On/Off" application note.

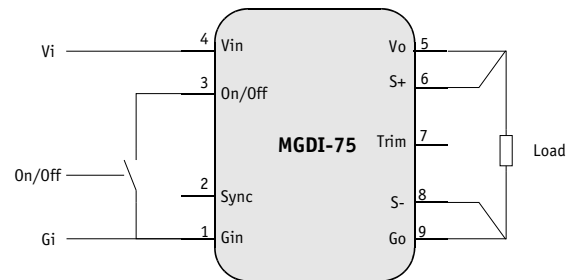

Parameter	Unit	Min.	Typ.	Max.	Notes, conditions
On/Off module enable voltage	Vdc	2	/	4,5	Open, the switch must not sink more than 100µA
On/Off module disable voltage	Vdc	0	/	0.5	The switch must be able to sink 1mA
On/Off module enable delay	ms	/	/	30	The module restarts with the same delay after alarm mode removed
On/Off module disable delay	µs	/	/	100	Vi nominal, full load

12-4 Synchronization Function

An external clock with rectangular «Pull Up» signals can be used to lock one or more converters. The external clock signal should have a frequency range from 420KHz to 480KHz, a low level below 0,5V a high level of 4V (+/-0.5V), a rise time of 30 ns max. and a drop time of 100ns max..

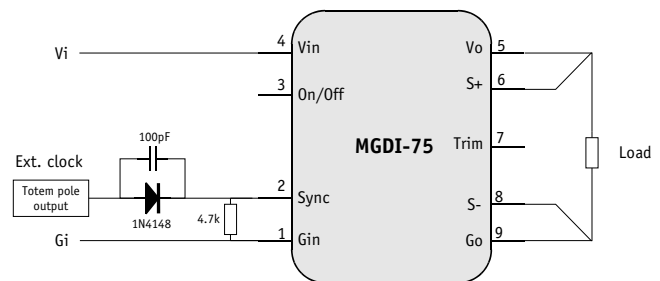
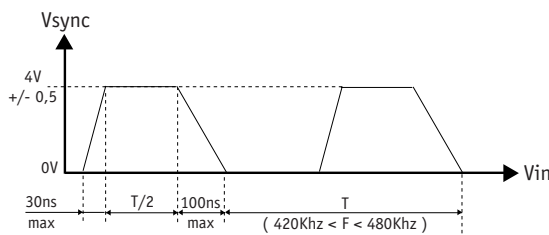

13- Dimensions

Dimensions are given in mm (inches). Tolerance : +/- 0,2 mm (+/- 0.01 ") unless otherwise indicated.
Weight : 70 grams (1.95 Ozs) max.

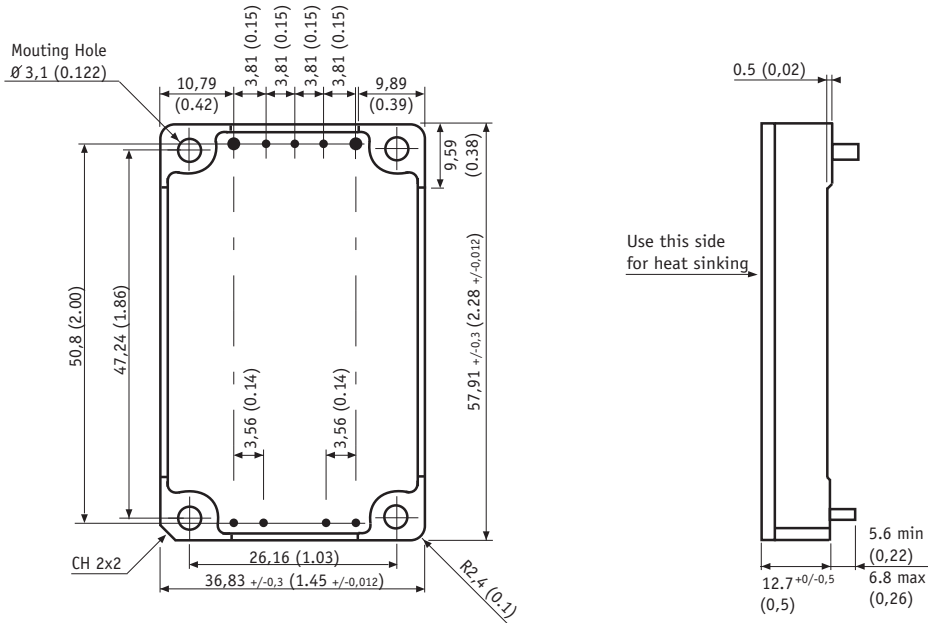

Pin dimensions :
Pins : 1, 2, 3, 4, 6, 7, 8 : Ø 1 mm (0.04")
Pins : 5, 9 : Ø 1,5 mm (0.059")

14- Materials

Frame : Aluminium alodined coating.
Baseplate : Copper with tin finishing.
Pins : Plated with pure matte tin over nickel underplate.

15- Product Marking

Side face : Company logo.
: Module reference : MGDSI-75-»X»-»Y».
Date code : year and week of manufacturing, suffix, /option.

16- Connections

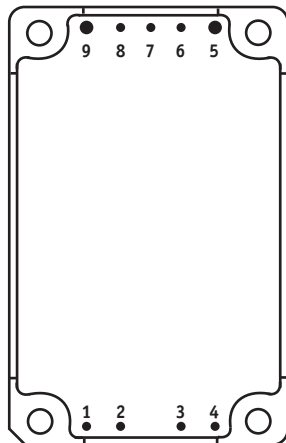

Bottom view

Pin	Single Output
1	- Input (Gi)
2	Synchro (Sync)
3	On/Off
4	+ Input (Vi)
5	+ Output (Vo)
6	Sense + (S+)
7	Trim (Trim)
8	Sense - (S-)
9	- Output (Go)



For more detailed specifications and applications information, contact :

International Headquarters

GAIA Converter - France
18 Rue Caroline Aigle
33186 LE HAILLAN - FRANCE
Tel. : + (33)-5-57-92-12-80
Fax : + (33)-5-57-92-12-89

North American Headquarters

GAIA Converter-Canada, INC
1405 Transcanada Hwy, Suite 520
DORVAL, QUEBEC, H9P 2V9
Tel. : (514)-333-3169
Fax : (514)-333-4519

Represented by :