



Hi-Rel DC/DC CONVERTER MGDD-60 : 60W POWER

Hi-Rel
Grade ■ ■

12:1 Ultra Wide Input Dual Outputs Metallic Case - 1 500 VDC Isolation



- Ultra wide input range MIL-STD-1275D/E
- Nominal power up to 60 W
- Nominal dual output voltage from 5V to 48V
- High efficiency over the entire range (typ. 91%)
- Soft start
- Galvanic isolation 1.500 VDC according to EN 60950
- Integrated LC input filter
- Permanent short circuit protection
- External synchronisation
- External trim adjustment : -20/+10%
- No optocoupler for high reliability
- RoHS process

1-General

The MGDD-60 ultra wide input series designates a full family of DC/DC power modules with a permanent ultra wide input voltage range of 12-160 volts designed for use in distributed power architecture where variable input voltage for multiple battery and transient are prevalent making them ideal particularly for avionics and military applications.

Also the MGDD-60 is compliant with the stringent requirements of MIL-STD-1275E standard that requires systems to sustain any 2 Joules injected spike that may occurs in less than 1ms, while the previous revision MIL-STD-1275D imposed only 15 milliJoules injected spikes.

Thanks to its 160 V maximum input voltage, the MGDD-60 series allows designer to sustain the MIL-STD-1275E spike with the simplest additional protection device : a 100V or higher TVS.

The serie includes dual output voltage choices individually isolated of 2 x 5 volts , 2 x 12 volts, 2 x 15 volts and 2 x 24 volts with easy configurability.

All the modules are designed with LC network filters to minimize reflected input current ripple. The modules include a soft-start, an input undervoltage lock-out, a permanent short circuit protection, a thermal protection and an output overvoltage limitation to ensure efficient module protections. The soft-start allows current limitation and eliminates inrush current during start-up. The short circuit protection completely protects the modules against short-circuits of any duration by a shut-down and restores to normal when the overload is removed.

The modules are potted with a bi-component thermal conductive compound to ensure optimum power dissipation under harsh environmental conditions.

4

2-Product Selection

Dual output model : MGDD - 60 - - /

Input Voltage Range	
Permanent	Transient
R : 12-160 VDC	10,7 VDC / 1 s

Output
C : 2 x 5 VDC
E : 2 x 12 VDC
F : 2 x 15 VDC
I : 2 x 24 VDC

Options :

- /T : option for -55°C start up operating temperature
- /S : option for screening and serialization

2- Product Selection (continued)

Input range	Output	Current	Reference	Options
12-160 VDC	2 x 5 VDC	5 A	MGDD-60-R-C	/T, /S
12-160 VDC	2 x 12 VDC	2,5 A	MGDD-60-R-E	/T, /S
12-160 VDC	2 x 15 VDC	2 A	MGDD-60-R-F	/T, /S
12-160 VDC	2 x 24 VDC	1,25 A	MGDD-60-R-I	/T, /S

Using various parallel or series connections of outputs, and the 80/110% trim capability, allows to cover almost the complete range of output voltages from 4V to 52V as shown in the table below.

Reference	Parallel Connection	Series Connection
MGDD-60-R-C	4 - 5,5 VDC	8 - 11 VDC
MGDD-60-R-E	9,6 - 13,2 VDC	19,2 - 26,4 VDC
MGDD-60-R-F	12 - 16,5 VDC	24 - 33 VDC
MGDD-60-R-I	19,2 - 26,4 VDC	38,4 - 52,8 VDC

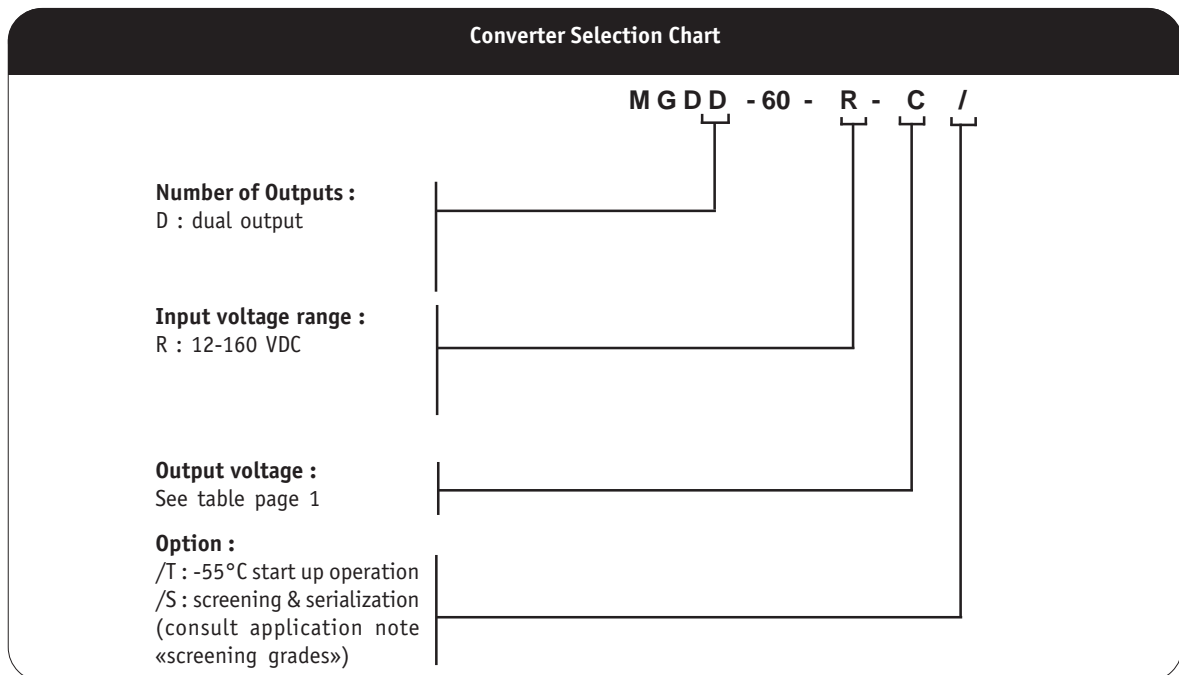

3- Block Diagram and Pin Description

The MGDD-60 is based on a new generation platform that enhanced flyback topology allowing ultra wide input range above 12:1 excursion from 12 to 160 V input voltage.

The MGDD-60 includes also a new isolated error amplifier technology that provides an accurate full range load regulation.

The double output combined to the trim function allows multiple combinations to achieves most of the standards required voltages i.e 5V-9V-10V-12V-15V-24V-28V-30V-32V-48V-52V, and more over.

The MGDD-60 module block diagram together with the pin allocation and description are presented in figures below.

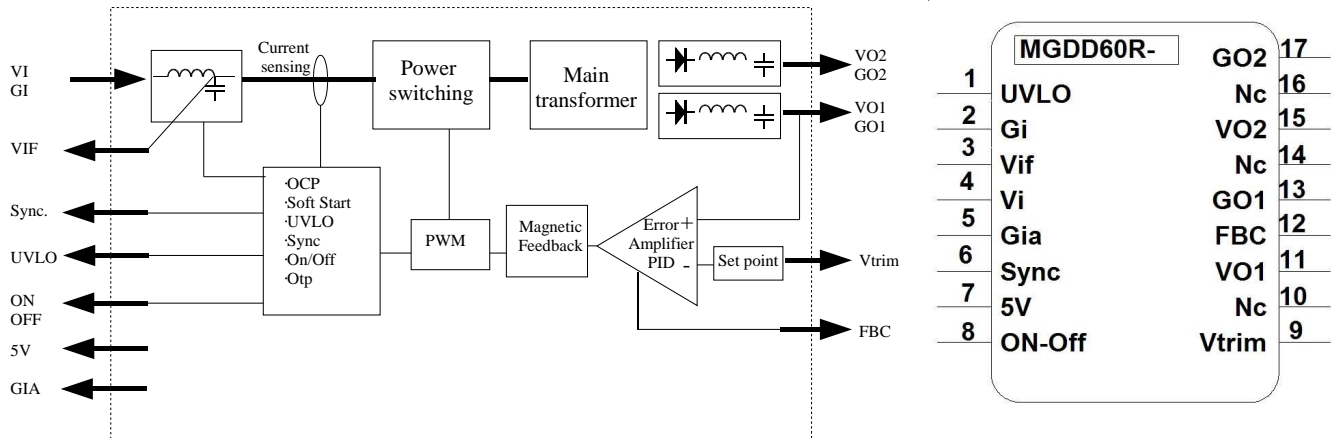

Pin Description :

UVLO : this pin gives the ability to user to increase the UVLO value (Under voltage Lock out), in order to stop converter operation when input voltage reach a given value.

Gi : Input bus return lead.

Vif : This pin give direct access to Input filter capacitor in order to increase drastically EMI performance using an external capacitance connected between Vif and Gi as close as possible to the Converter leads.

Vi: Input bus lead.

GIA : Auxiliary Ground. This pin is a low noise ground that can be used for monitoring low power circuitry that cannot be referenced to high power noisy ground. GIA is internally connected to GI.

Sync : Sync pin is a bidirectional pin that allows user to synchronize several converters together or to an external signal. see chapter 13 for sync signal application.

5V : auxiliary supply voltage that can be used for external low power monitoring circuits.

On/Off : when this pin is pulled to GIA, the converter stops operation. When converter encounter a over temperature condition, this pin is internally pulled to Gia level

Go2 : return terminal of output 2

VO2 : output 2 terminal

GO1 : return terminal of output 1

VO1 : output 1 terminal. The output one is considered as the main output, and must be priorly loaded.

FBC : Feed Back Compensation can be used for optimizing the dynamic regulation response for fast load shift. In normal operation, this pin should be let not connected, consult factory for more details.

Vtrim : Voltage trimming input: using simple resistor connected between this pin and Vo1 or Go1 allow user to trim ouput voltage in -20/+10% range.

4- Electrical Specifications

Data are valid at +25°C, unless otherwise specified.

Parameter	Conditions	Limit or typical	Units	Dual Output MGDD-60 - R
Input				
Nominal input voltage	Full temperature range	Nominal	VDC	28
Permanent input voltage range (Ui)	Full temperature range	Min. - Max.	VDC	12-160
Transient input voltage	Full load	Minimum	VDC/S	10,7 / 1
Undervoltage lock-out (UVLO)	Turn-on voltage (pin Uvlo open)	Maximum	VDC	11,8
	Turn-off voltage (pin Uvlo open)	Maximum	VDC	10,5
Start up time	Ui nominal within 3 ms Nominal output Full load : resistive	Maximum	ms	30
Reflected ripple current	Ui nominal, full load at switching freq. BW = 20MHz	Maximum	% Inom.	TBD
No load input power	Ui nominal No load	Maximum	W	1
Standby input power	Ui nominal	Maximum	W	1
Output				
Output voltage	Full temperature range	Nominal	VDC	2 x 5
	Ui min. to max.	Nominal	VDC	2 x 12
	75% load	Nominal	VDC	2 x 15
		Nominal	VDC	2 x 24
Set Point accuracy	Ambient temperature : +25°C Ui nominal, 75% load	Maximum	%	+/- 2
Total output power with both outputs	Full temperature range Ui min. to max.	Maximum	W	60
Output current per output				
5V output	Full temperature range Ui min. to max.	Nominal	A	5,0
12V output		Nominal	A	2,5
15V output		Nominal	A	2,0
24V output		Nominal	A	1,25
Unbalanced output	Minimum load on Vo1 for Vo2 proper operation	Typical	W	6
Ripple output voltage **				
5V output	Ui nominal	Maximum	mVpp	200
12V output	Full load	Maximum	mVpp	240
15V output	BW = 20MHz	Maximum	mVpp	300
24V output		Maximum	mVpp	520
Output regulation * (Line + load + thermal)	Ui min. to max. 0% to full load	Maximum	%	+/- 1,5
Output voltage trim	As a function of output voltage	Minimum	%	80
		Maximum	%	110
Maximum admissible capacitive load				
5V output	Ui nominal	Maximum	µF	2 200
12V output	Full load	Maximum	µF	820
15V output	Per output	Maximum	µF	680
24V output		Maximum	µF	470
Efficiency	Ui nominal	Typical	%	up to 91
	Full load			

Note : Modules have to be mounted with heatsink for electrical tests.

Note * : Regulation is measured with both outputs in parallel configuration.

Note ** : The ripple output voltage is the periodic AC component imposed on the output voltage, an aperiodic and random component (noise) has also to be considered. This noise can be reduced by adding 1 external decoupling capacitor connected between Gin and Gout. These capacitance should be layed-out as close as possible from the converter. The ripple output voltage is measured by connecting a ceramic chip capacitor Co across Vo and Go pins (C=100µF if Vo<5Vdc C=10µF if Vo>5Vdc)

4- Electrical Characteristics (continued)

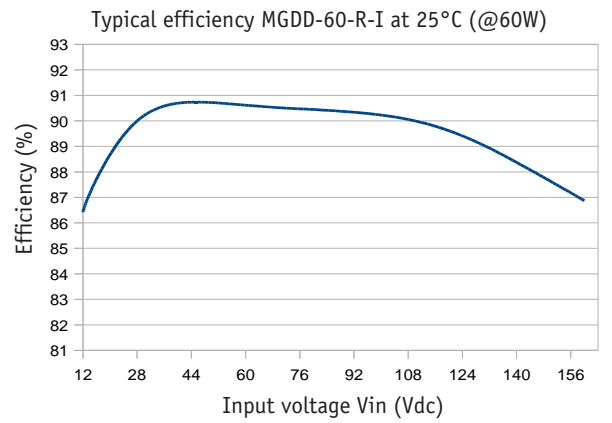
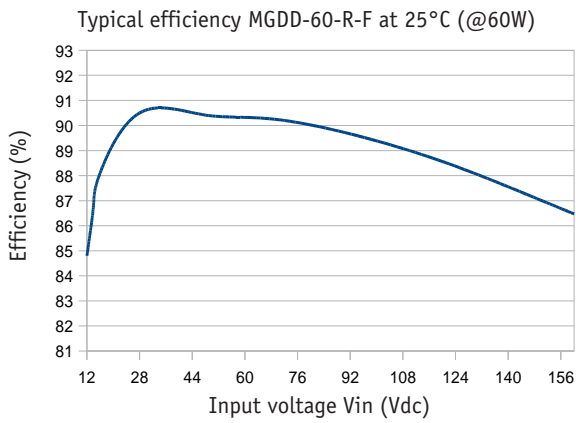
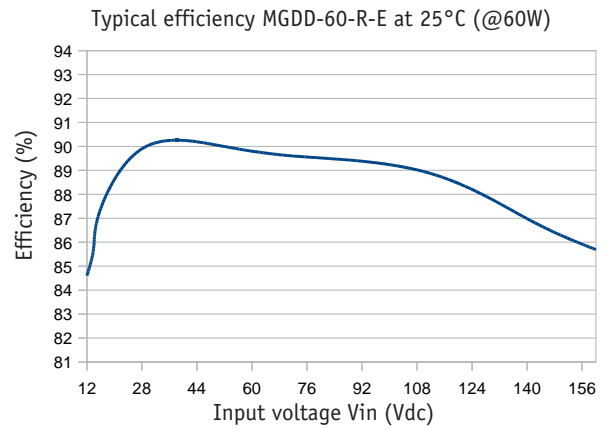
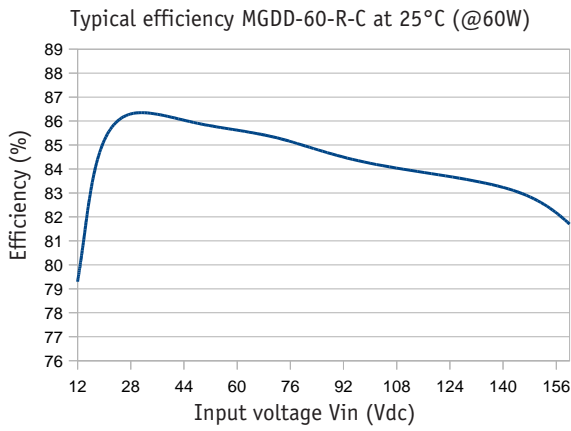

5- Switching Frequency

Parameter	Conditions	Limit or typical	Specifications
Switching frequency	Full temperature range Ui min. to max. No load to full load	Nominal, fixed	270 KHz

6- Isolation

Parameter	Conditions	Limit or typical	Specifications
Electric strength test voltage	Input to output Between outputs	Minimum Minimum	1 500 VDC / 1 min 300 VDC / 1 min
Isolation resistance	Input to case 500 VDC Output to case 500 VDC	Minimum Minimum	100 MOhm 100 MOhm

7- Protection Functions

Characteristics	Protection Device	Recovery	Limit or typical	Specifications
Input undervoltage lock-out (UVLO)	Turn-on, turn-off circuit with hysteresis cycle	Automatic recovery	Turn-on nominal Turn-off nominal	See section 3
Output current limitation protection (OCP)	Straight line current limitation	Automatic recovery	Nominal	130%
Output overvoltage protection (OVP)	Overvoltage protection limitation	Automatic recovery	Nominal	130% of output voltage
Over temperature protection (OTP)	Thermal device with hysteresis cycle	Automatic recovery	Nominal	125°C

8- Reliability Data

Characteristics	Conditions	Temperature	Specifications
Mean Time Between Failure (MTBF) According to MIL-HDBK-217F	Ground benign (Gb)	Case at 40°C	2 175 000 Hrs
	Ground fixed (Gf)	Case at 40°C	680 000 Hrs
		Case at 85°C	235 000 Hrs
Mean Time Between Failure (MTBF) According to IEC-62380-TR	Airborne Inhabited Cargo (AIC)	Case at 40°C	395 000 Hrs
		Case at 85°C	150 000 Hrs
Mean Time Between Failure (MTBF) According to IEC-62380-TR	Aircraft, Civilian	Ambient at 25°C 100% time on	740 000 Hrs

9- Electromagnetic Interference and Surge

Electromagnetic Interference requirements according to MIL-STD-461C/D/E standards can be easily achieved as indicated in the following section. The following table resumes the different sections covered by these standards.

Standard Requirements	MIL-STD-461C Standard	MIL-STD-461D/E Standard	Compliance with GAIA Converter Module & common mode capacitance
Conducted emission (CE) : Low frequency High frequency	CE 01 CE 03	CE 101 CE 102	compliant module stand-alone compliant with additional filter
Conducted susceptibility (CS) : Low frequency High frequency	CS 01 CS 02	CS 101 CS114	compliant with additional filter compliant with additional filter
Radiated emission (RE) : Magnetic field Electrical field	RE 01 RE 02	RE 101 RE 102	compliant module stand-alone compliant module stand-alone
Radiated susceptibility (RS) : Magnetic field Electrical field	RS 01 RS 03	RS 101 RS 103	compliant module stand-alone compliant module stand-alone

9-1 Module Compliance with MIL-STD-461C/D/E Standards

To meet the latest US military standards MIL-STD-461 requirements and in particular the conducted noise emission CE102 (and also CE03) requirements, Gaia Converter can propose an EMI filter module. In addition common mode capacitances C_{mc} (10nF/rated voltage depending on isolation requirement) connected between power pins and chassis or ground power-plane need to be implemented. When output channels are intended to be connected to load through long wire, it could be necessary to use additionally common mode inductors on each outputs. For a use at 28Vdc C7 can be rated to 47 μ F.

Please consult FGDS-serie

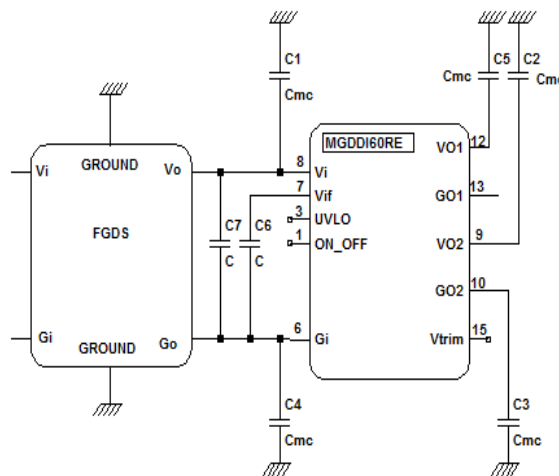

9- Electromagnetic Interference and Surge (continued)

9-2 Module Compliance with MIL-STD-1275D/E Standards

Surge requirements according to MIL-STD-1275D/E standards can be easily achieved as indicated in the following section.

The MIL-STD-1275E standard requires that systems sustain any **2 Joules** injected spike that may occurs in less than 1ms, while the previous revision MIL-STD-1275D imposed only **15milliJoules** injected spikes.

MIL-STD-1275D : 15 mJ injected spike

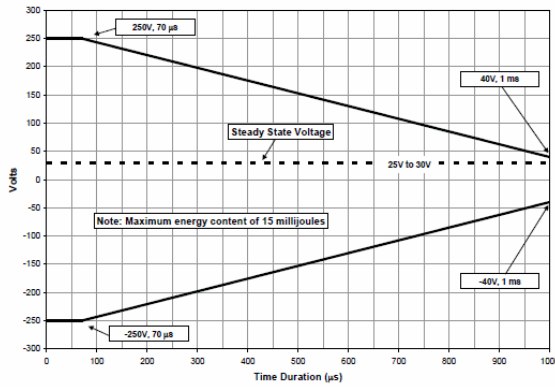

MIL-STD-1275E : 2 J injected spike

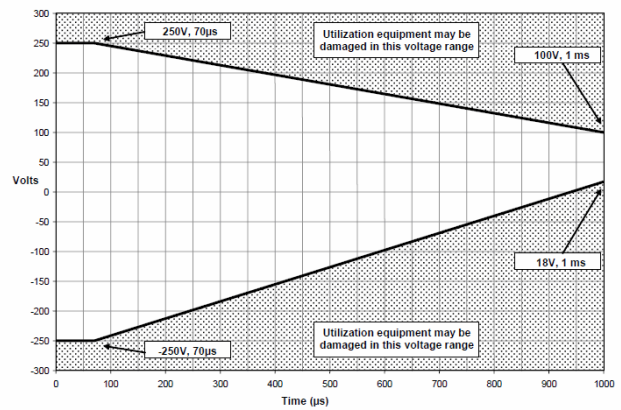

Thanks to its 160 V maximum input voltage, the MGDD60 series allows designer to comply the MIL-STD-1275E with a simple additional protection devices.

The proposed schematics below allows to sustain MIL-STD 1275E. The two TVS D1 and D2 clamp the 2 joules input transient below 160V maximum. This 1ms max. transient can go through filter without damaging it, and does not make problem for the 160 V MGDD-60-R converter series. When the transient appears in its negative form, it is blocked by the D4 diode. In this case, C1 energy reserve can supply the MGDD-60-R during the transient duration in order not to interrupt operation. D1 and R1 limit inrush current when C1 is starting charging.

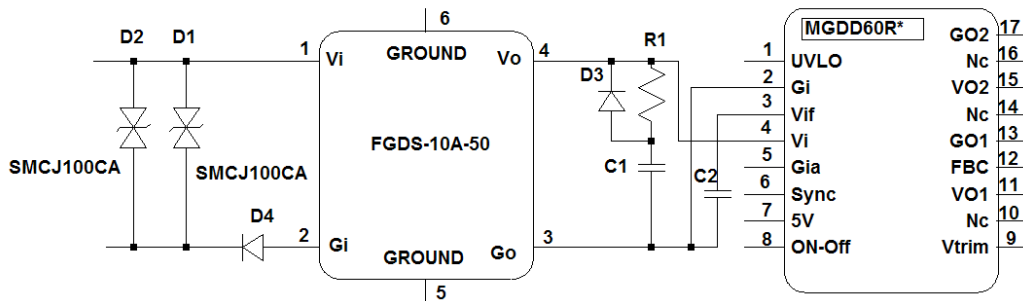

2 Joules protection

Components	Type	Reference
D1	SMJ100CA	1,5 KW TVS
D2	SMJ100CA	1,5 KW TVS
D3	MBR7100	7A/100V Schottky
D4	MBR7150	7A/150V Schottky
R1	/	10 Ohm / 5W
C1	/	680µF 100V aluminium
C2	/	1 to 4,7µF ceramic 100V

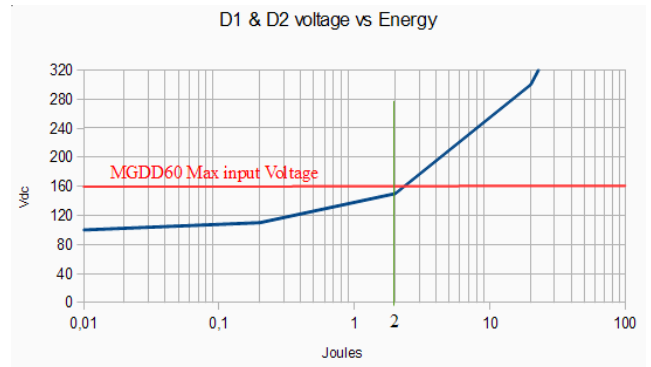

Also, the MGDD-60 allows operation with 10,5 Vdc during 1s, that makes it compliant with the MIL-STD-1275E standard (IES initial engagement surge) without necessity to add any additional circuit like boost or large hold up capacitor.

10- Thermal Characteristics

Characteristics	Conditions	Limit or typical	Performances
Operating ambient temperature range	Ambient temperature	Minimum Maximum	- 40°C see below
Operating case temperature range at full load	Case temperature	Minimum Maximum	- 40°C see curves hereafter
Storage temperature range	Non functioning	Minimum Maximum	- 55°C + 125°C
Thermal resistance	Rth case to ambient in free air natural convection	Typical	6,5°C /W

The following discussion will help designer to determine the thermal characteristics and the operating temperature.

Heat can be removed from the baseplate via three basic mechanisms :

- Radiation transfert : radiation is counting for less than 5% of total heat transfert in majority of case, for this reason the presence of radiant cooling is used as a safety margin and is not considered.
- Conduction transfert : in most of the applications, heat will be conducted from the baseplate into an attached heatsink or heat conducting member; heat is conducted thru the interface.
- Convection transfert : convecting heat transfer into air refers to still air or forced air cooling.

In majority of the applications, we will consider that heat will be removed from the baseplate either with :

- heatsink,
- forced air cooling,
- both heatsink and forced air cooling.

To calculate the maximum admissible ambient temperature the following method can be used.

Knowing the power used P_{out} and the efficiency η :

- determine the power dissipated by the module P_{diss} that should be evacuated :

$$P_{diss} = P_{out}(1/\eta - 1) \quad (A)$$

- then determine the thermal dissipation :

$$T_{diss} = R_{th}(b-a) \times P_{diss} \quad (B)$$

where **$R_{th}(b-a)$** is the thermal resistance from the baseplate to ambient.

This thermal $R_{th}(b-a)$ resistance is the sum of :

- the thermal resistance of baseplate to heatsink (**$R_{th}(b-h)$**). The interface between baseplate and heatsink can be nothing or a conducting member, a thermal compound, a thermal pad.... The value of $R_{th}(b-h)$ can range from 0.4°C/W for no interface down to 0.1°C/W for a thermal conductive member interface.
- the thermal resistance of heatsink to ambient air (**$R_{th}(h-a)$**), which is depending of air flow and given by heatsink supplier.

The table hereafter gives some example of thermal resistance for different heat transfert configurations.

Heat transfert	Thermal resistance heatsink to air $R_{th}(h-a)$	Thermal resistance baseplate to heatsink $R_{th}(b-h)$	Global resistance
Free air cooling only	No Heatsink baseplate only : 6,5°C/W	No need of thermal pad	6,5°C/W
	Heatsink Aavid Thermalloy 824353B03250 3,9°C/W	Bergquist Silpad* : 0,13°C/W	4,03°C/W
Forced air cooling 200 LFM	No Heatsink baseplate only : 3,8°C/W	No need of thermal pad	3,8°C/W
	Heatsink Aavid Thermalloy 824353B03250 2,1°C/W	Bergquist Silpad* : 0,13°C/W	2,23°C/W
Forced air cooling 400 LFM	No Heatsink baseplate only : 2,63°C/W	No need of thermal pad	2,63°C/W
	Heatsink Aavid Thermalloy 824353B03250 1,5°C/W	Bergquist Silpad* : 0,13°C/W	1,63°C/W
Forced air cooling 1000 LFM	No Heatsink baseplate only : 1,54°C/W	No need of thermal pad	1,54°C/W
	Heatsink Aavid Thermalloy 824353B03250 1°C/W	Bergquist Silpad* : 0,13°C/W	1,13°C/W

Aavid Thermalloy is a heatsink manufacturers. «Silpad» ® is a registered trademark of Bergquist.
Note* : Silpad performance are for Silpad 400 with pressure conditions of 50 Psi.

10- Thermal Characteristics (continued)

The two formulas (A) and (B) described in previous page :

- $P_{diss} = P_{out}(1/\eta - 1)$ (A)
- $T_{diss} = R_{th}(b-a) \times P_{diss}$ (B)

conduct to determine the maximum ambient temperature admissible as a function of the maximum baseplate temperature of the module.

Knowing the maximum baseplate temperature $T_{max_{baseplate}}$ the maximum ambient temperature is given by the following formula :

$$T_a = T_{max_{baseplate}} - T_{diss} \quad (C)$$

MGDD-60 Series Maximum Baseplate Temperature Versus % of Maximum Output Power

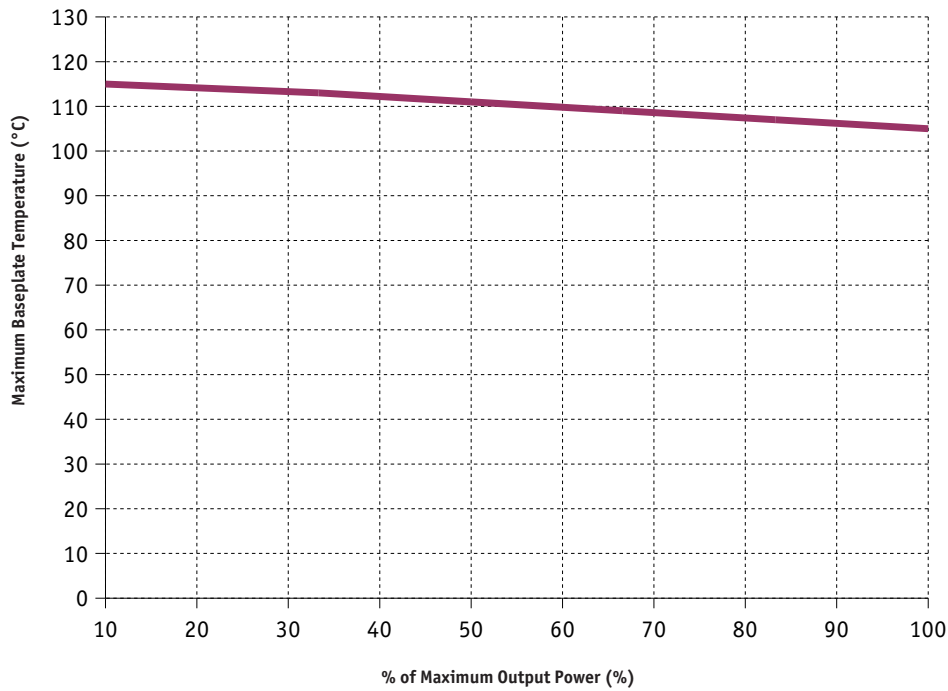

11- Environmental Qualifications

The modules have been subjected to the following environmental qualifications.

Characteristics	Conditions	Severity	Test procedure
Climatic Qualifications			
Life at high temperature	Duration Temperature / status of unit	Test D : 1 000 Hrs @ 105°C case, unit operating @ 125°C ambient, unit not operating	MIL-STD-202G Method 108A
Altitude	Altitude level C Duration Climb up Stabilization Status of unit	40 000 ft@-55°C 30 min. 1 000 ft/min to 70 000 ft@-55°C, 30 min. unit operating	MIL-STD-810E Method 500.3
Humidity cyclic	Number of cycle Cycle duration Relative humidity variation Temperature variation Status of unit	10 Cycle I : 24 Hrs 60 % to 88 % 31°C to 41°C unit not operating	MIL-STD-810E Method 507.3
Humidity steady	Damp heat Temperature Duration Status of unit	93 % relative humidity 40°C 56 days unit not operating	MIL-STD-202G Method 103B
Salt atmosphere	Temperature Concentration NaCl Duration Status of unit	35°C 5 % 48 Hrs unit not operating	MIL-STD-810E Method 509.3
Temperature cycling	Number of cycles Temperature change Transfert time Steady state time Status of unit	200 -40°C / +85°C 40 min. 20 min. unit operating	MIL-STD-202A Method 102A
Temperature shock	Number of shocks Temperature change Transfert time Steady state time Status of unit	100 -55°C / +105°C 10 sec. 20 min. unit not operating	MIL-STD-202G Method 107G
Mechanical Qualifications			
Vibration (Sinusoidal)	Number of cycles Frequency / amplitude Frequency / acceleration Duration Status of unit	10 cycles in each axis 10 to 60 Hz / 0.7 mm 60 to 2 000 Hz / 10 g 2h 30 min. per axis unit not operating	MIL-STD-810D Method 514.3
Shock (Half sinus)	Number of shocks Peak acceleration Duration Shock form Status of unit	3 shocks in each axis 100 g 6 ms 1/2 sinusoidal unit not operating	MIL-STD-810D Method 516.3
Bump (Half sinus)	Number of bumps Peak acceleration Duration Status of unit	2 000 Bumps in each axis 40 g 6 ms unit not operating	MIL-STD-810D Method 516.3

12- Description of Protections

The MGDD-60 series includes 4 types of protection devices.

12-1 Input Undervoltage Lockout (UVLO)

An input undervoltage protection will inhibit the module when input voltage drops below the lock-out turn-off threshold (see section 3 for value) and restores to normal operation automatically when the input voltage rises the lock-out turn-on threshold.

The UVLO voltage can be adjusted using a resistor (Ruvlo) connected between pin (1) and GIA. This value can be adjusted in order to allow converter to stop properly accordingly to the input bus (or battery) voltage value. The Ruvlo can be determined using the following formula :

$$R_{uvlo} (K\Omega) = [200.3 - V_{uvlo}] / [V_{uvlo} - 11.8]$$

Ruvlo = trimming resistance

Vuvlo = desire turn-on voltage

Without resistor, the turn on voltage is 11.8V and turn off voltage is 10.5V

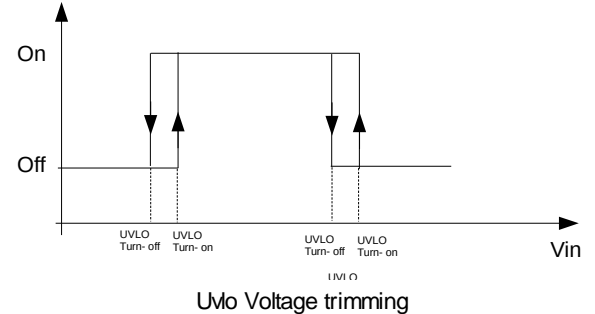
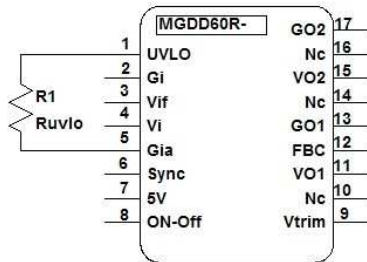

Uvlo Voltage trimming

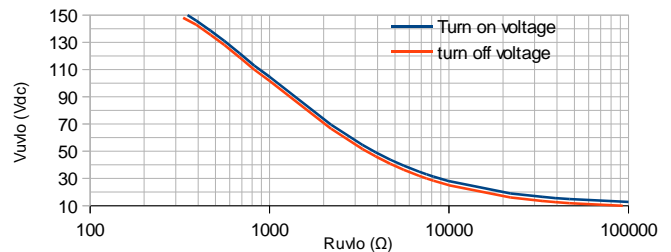

12-2 Output Over Current Limitation Protection (OCP)

The MGDD-60 Series incorporates an overcurrent protection circuit. The overcurrent protection detects short circuit or over current and protects the module according to the hiccup graph. The maximum detection current Id is depending on input voltage Vin, temperature, and is higher than 105 % maximum nominal output current.

When OCP is triggered, the converter falls in hiccup mode by testing periodically if the overload is still present. The module restart automatically in soft-start to normal operation when overcurrent is removed. Td (detection time) and Th (hiccup period) are depending on Vin and temperature. In hiccup mode the average current is around 25 % of Inom.

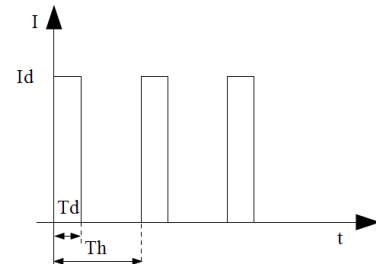

12-3 Output Overvoltage Protection (OVP)

The MGDD-60 series has an internal overvoltage limitation protection circuit that monitors the voltage across the output power terminals. It is designed to limit the converter output voltage to 130% (+/-10%) of nominal output voltage.

12-4 Over Temperature Protection (OTP)

A thermal protection device adjusted at 125°C (+/-5%) internal temperature with 10°C hysteresis cycle will inhibit the module as long as the overheat is present and restores to normal operation automatically when overheat is removed. The efficiency of the OTP function is warranty with the module mounted on a heatsink.

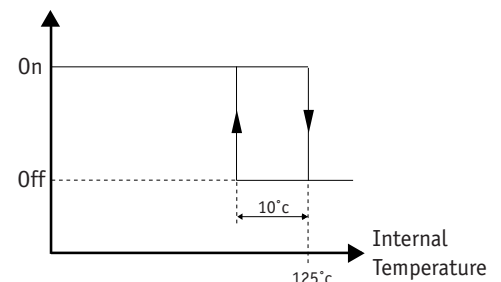

13- Description of Functions

13-1 Connection of Outputs

The outputs of MGDD-60 can be connected in various configurations such as :

- connections in series
- connection in parallel
- connection in symmetry
- connection in inderpendance

Please note that regulation is achieved through output VO1/GO1 referenced as primary output. When connected in symetrie or independent configurations with unbalanced loads, VO1/GO1 has to be loaded at 6W minimum to insure proper operating of the converter. The VO2/GO2 output referenced as secondary output may stay unloaded, but in that case its regulation may drift up as shown in curve below. There is no minimum load when the two outputs are connected in parallel or balanced serie.

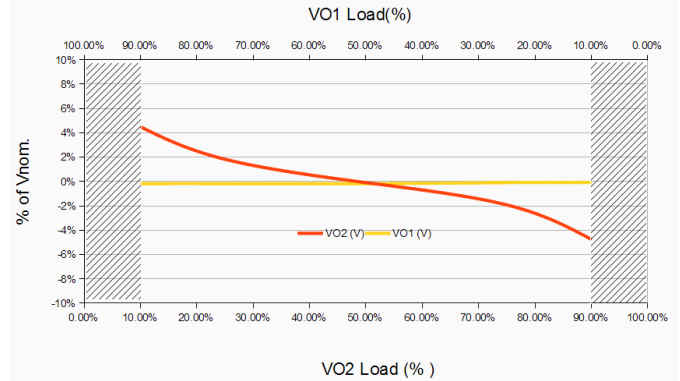
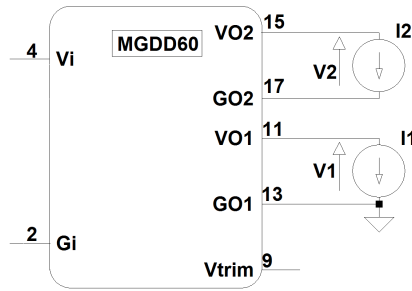

13-1-1 Connection of Outputs in Series

Outputs connected in series allow to achieve 10V, 24V, 30V or 48V output voltages up to 60W total power. These values can be extended using trim adjustment.

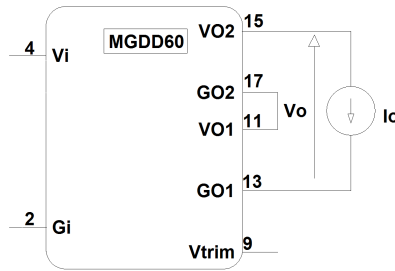

13-1-2 Connection of Outputs in Parallel

Outputs connected in paralell allow to achieve single output 5V, 12V, 15V or 24V up to 60W power. These values can be extended using trim adjustment.

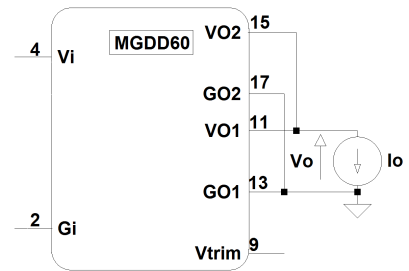

13-1-3 Connection of Outputs in Symmetry

Outputs connected in symmetry allow to achieve +/-5V, +/-12V, +/-15V or +/-24V voltages (+/-30W each) with possible unbalanced load up to 50W on primary output, 10W on secondary output and vice versa.

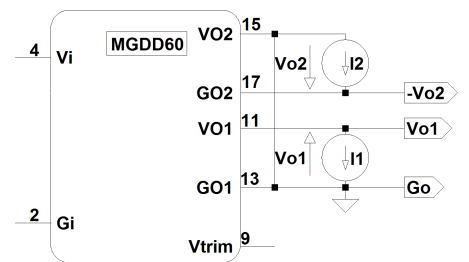

13-1-4 Connection of Outputs in Independance

Outputs connected independantly with floating DC between each other can be achieved for 2x5V, 2x12V, 2x15V or 2x24V voltages (30W each) with possible unbalanced load up to 50W on primary output 10W on secondary output and vice versa.

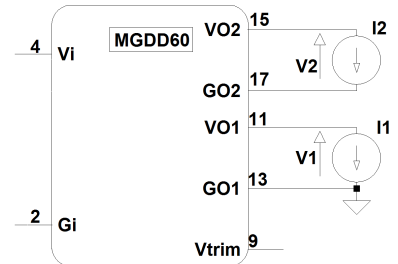
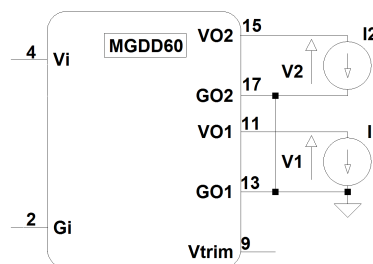

13- Description of Functions

13-2 Trim Function

The output voltage Vo1 and Vo2 may be trimmed in a range of 80%/110% of the nominal output voltage via a single external trimpot or fixed resistor. When the converter is trimmed by resistor, both output will be trimmed at the same value.

Trim Up Function

Do not attempt to trim the module higher than 110% of nominal output voltage as the overvoltage protection may occur.

Also do not exceed the maximum rated output power when the module is trimmed up.

The trim up resistance must be calculated with the following formula :

$$R_u(k\Omega) = \frac{(R1 * VO_{nom} * (VO - V_{ref}))}{((VO - VO_{nom}) * V_{ref})} - R1 - R2$$

Trim Down Function

Do not trim down more than -20% of nominal output voltage otherwise the module may be affected.

The available output power is reduced by the same percentage that output voltage is trimmed down.

The trim down resistance must be calculated with the following formula :

$$R_d(k\Omega) = \frac{((R1 + R2) * VO - (R2 * VO_{nom}))}{(VO_{nom} - VO)}$$

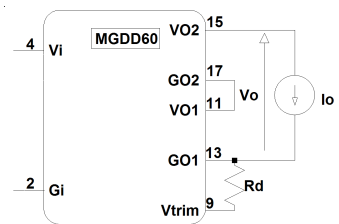
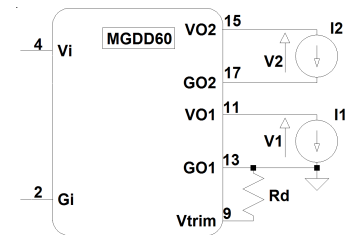
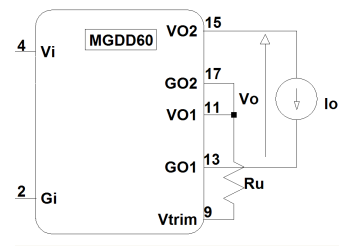
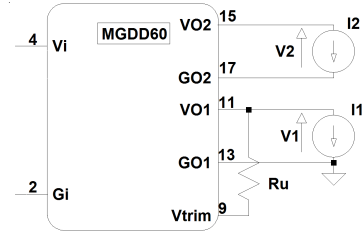

Parameter	Unit	Min.	Typ.	Max.
Trim reference Vref	Vdc	1,2	1,225	1,25
Resistor R1	Ohm	/	3,9K	/
Resistor R2	Ohm	/	270	/

13- Description of Functions (continued)

13-3 On/Off Function

The control pin 8 (On/Off) can be used for applications requiring On/Off operation. This may be done with an open collector transistor, a switch, a relay or an optocoupler. Several converters may be disabled with a single switch by connecting all On/Off pins together.

- The converter is disabled by pulling low the pin 8.
- No connection or high impedance on pin 1 enables the converter.

By releasing the On/Off function, the converter will restart within the start up time specifications given in table section 3.

The pin On/off can also be used as over temperature protection (OTP) indicator. When the voltage level on pin On/Off is higher than 3.5Vdc, the OTP is not triggered. When the voltage level on pin On/Off is lower than 0.5Vdc and external on/off not activated, the OTP is triggered.

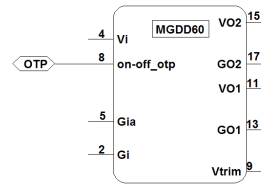
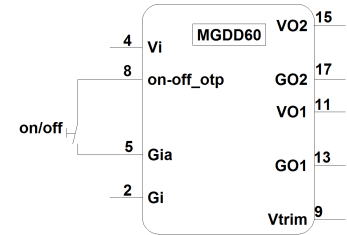

Parameter	Unit	Min.	Typ.	Max.	Notes, conditions
On/Off module enable voltage	Vdc	2.1	/	3.3	Open, the switch must not sink more than 50µA
On/Off module disable voltage	Vdc	0	/	0.5	The switch must be able to sink 0,5mA
On/Off alarm level	Vdc	0	/	0.5	OTP faulty module
On/Off module enable delay	ms	/	/	30	The module restarts with the same delay after alarm mode removed
On/Off module disable delay	µs	/	/	100	Vi nominal, full load

13-4 Synchronization (SYNC)

The «Sync» pin allows the synchronization of a module to an external frequency source or to another MGDD-60 module. The pin is bidirectionnal and must be driven by an open drain circuitry providing a square wave signal (active on falling edge) with a frequency ranging between 285kHz to 310kHz. Higher frequency synchronization is possible, please consult factory. The characteristics of the signal are detailed in the figure hereunder : ($t_r, t_f < 30ns$; $100ns < T_p < 400ns$)

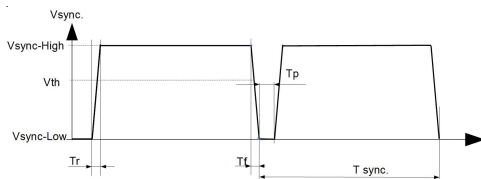
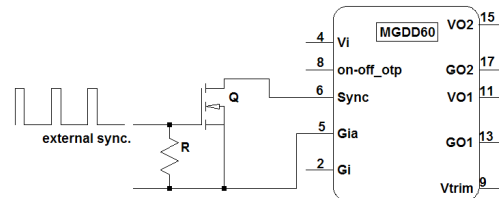

13-5 Input Filter Compensation (VIF)

The «VIF» pin is a direct access to the capacitor of the LC input filter and allows to increase the C value to enhance the converter's stability and performance and to reduce the input current ripple for improved EMI performance. It is recommended to provide low ESR ceramic capacitors, total value can range from 2.2µF for high input voltage use to 10µF for low input voltage use. These capacitors should have the proper voltage rating. Because of high current flowing through it, it should be connected between «VIF» and «Gin» as close as possible from the converter, using large copper traces.

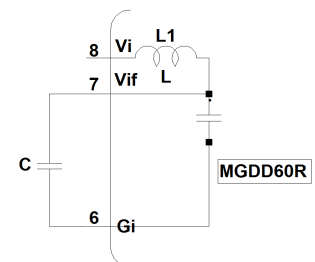

14- Dimensions

Dimension are given in mm. Tolerance : +/- 0,2 mm (+/- 0.01 ") unless otherwise indicated.
Weight : 110 grams (4 Ozs) max.

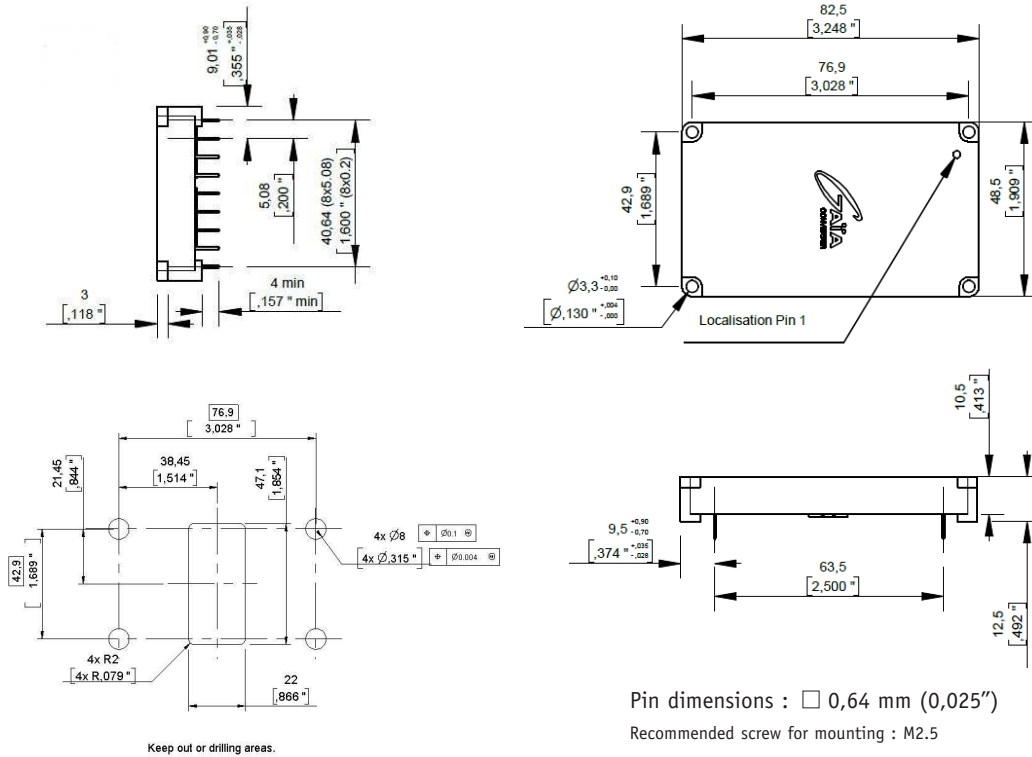

15- Materials

Case : Metallic black anodized coating.
Pins : Flash gold plating over nickel underplate.

16- Product Marking

Upper face : Company logo.
Side face : Module reference, option, date code : year and week of manufacturing.

17- Connections

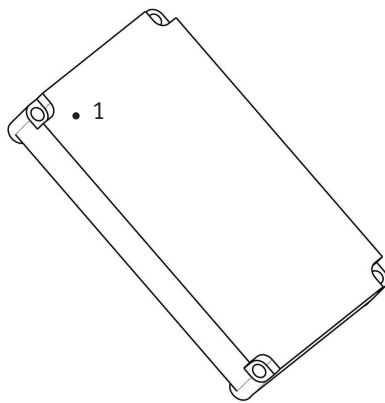

Top view

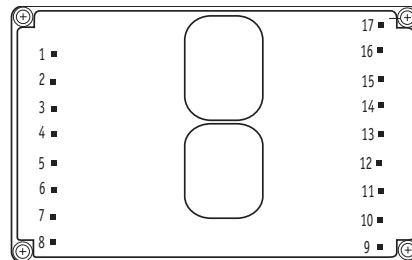

Bottom view

Pin	Single
1	UVLO
2	- Input (Gi)
3	VIF
4	+ Input (Vi)
5	GIA
6	Sync
7	5V
8	On/Off-OTP
9	Vtrim
10	Do not connect
11	+ Output 1 (Vo1)
12	Do not connect
13	- Output 1 (Go1)
14	Do not connect
15	+ Output 2 (Vo2)
16	Do not connect
17	- Output 2 (Go2)



For more detailed specifications and applications information, contact :

International Headquarters

GAIA Converter - France
18 Rue Caroline Aigle
33186 LE HAILLAN - FRANCE
Tel. : + (33)-5-57-92-12-80
Fax : + (33)-5-57-92-12-89

North American Headquarters

GAIA Converter-Canada, INC
1405 Transcanada Hwy, Suite 520
DORVAL, QUEBEC, H9P 2V9
Tel. : (514)-333-3169
Fax : (514)-333-4519

Represented by :