



Hi-Rel LIMITOR MODULE LGDS-300 : up to 300W POWER

Hi-Rel Grade ■■■

Transient 80V or 100V Protection Module DO-160, MIL-STD-704 & MIL-STD-1275 Metallic Case

- Ultra compact limiter module
- Transient suppressor module 80V
 - MIL-STD-704A/D/E/F, EN2282, AIR2021E
 - D0160E cat A, B and Z
- Transient suppressor module 100V
 - MIL-STD-1275A/B/C/D,
- Power range : up to 300W
- Inrush current limitation
- RoHS process



1- General

The GAIA Converter limiter LGDS-300 is an ultra compact power adaptor module designed to allow operation during voltage transients and spikes, occurring in avionics or military systems. The LGDS-300 delivers an output voltage adapted to GAIA Converter DC/DC modules. This module is optimized to provide high power efficiency up to 99% over the whole power range up to 300W.

The LGDS-300 features 3 modes of operations as follow:

• **Normal operation :**

Normal operation occurs in between the permanent input voltage of the DC/DC converter; The LGDS-300 is then operating in steady transparency state.

• **Power fail operation :**

The power fail operation occurs when the input bus drops below 9 Vdc low voltage limit ; an undervoltage lock-out stops the LGDS-300.

• **Transient operation :**

The LGDS-300 clamps input transient up to 80V/100ms or 100V/50ms.

The LGDS-300 series is compliant with the international input bus standards :

- MIL-STD-704A/D/E/F
- AECMA EN2282
- GAM-EG13B/AIR2021E
- D0160E cat A, B and Z
- MIL-STD-1275A/B/C/D

The design has been carried out with surface mount components and is manufactured in a fully automated process to guarantee high quality. Every module is tested with a Gaia Converter automated test equipment. The modules are potted with a bi-component thermal conductive compound and packaged in a metallic case to ensure the module's integrity under severe environmental conditions.

4

2- Product Selection

LGDS - 300 - - /

Input Voltage Range
Transient
0 : 100V/50ms

Output
K

Options :

- /T : option for -55°C start up operating temperature
- /S : option for screening and serialization

3- Modes of Operation

3-1 LGDS-300 Modes of Operation

The LGDS-300-0-K operates with H input family of GAIA Converter DC/DC Converters.

The LGDS-300-0-K features 3 modes of operations as describes in the following state diagram :

• Normal operation :

Normal operation occurs in between 9V and 42V input voltage; the module is then operating in steady transparency state.

• Power fail operation :

When a failure occurs such as an undervoltage, an over current or an over temperature, the LGDS-300 turns to power fail mode and stops operation until the failure is removed. The LGDS-300 features 3 protection functions : input undervoltage lockout (UVLO), output over current protection (OCP) and over temperature protection (OTP).

• Transient operation :

When a surge occurs, the LGDS-300 turns to transient mode operation. It clamps input transient up to 100V as long as 50ms, while the output voltage remains at 42V.

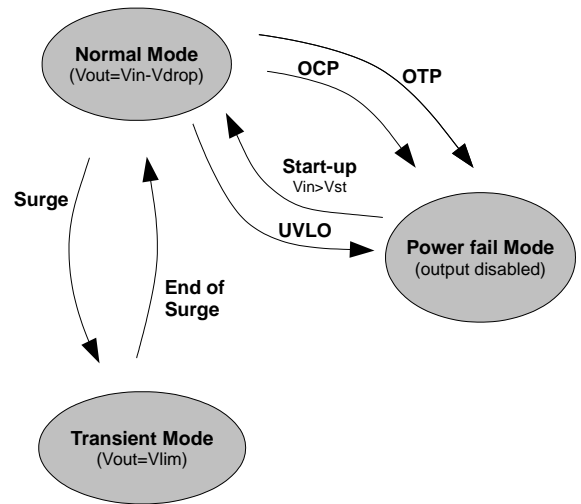

OTP : Over Temperature Protection
OCP : Over Current Protection

LGDS-300 Transfer Function

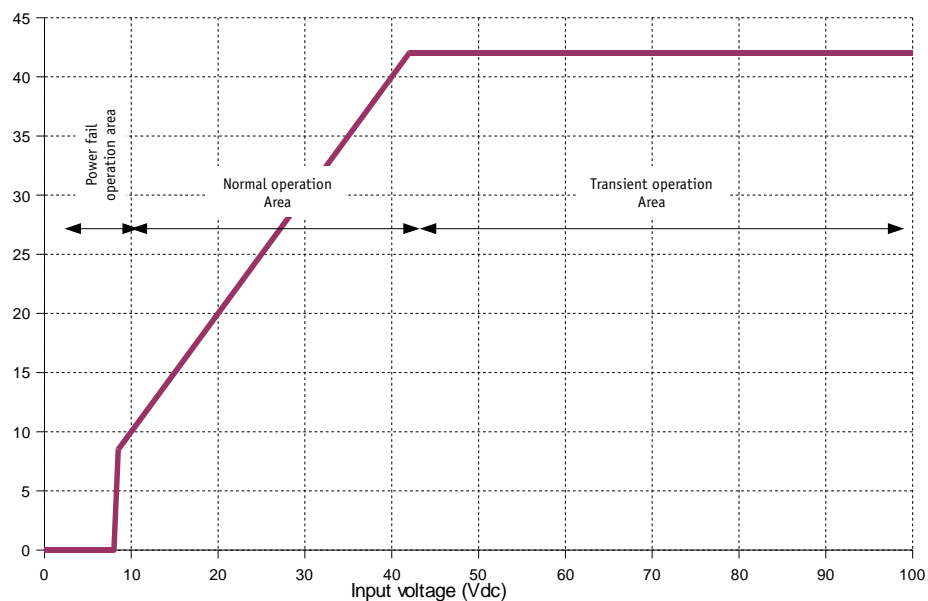

4- Electrical Specifications

Data are valid at +25°C, unless otherwise specified.

Parameter	Conditions	Limit or typical	Units	LGDS-300
Input				
Permanent input voltage range (U _i) in normal operation	Full temperature range	Minimum	VDC	9
	Full load	Maximum	VDC	42
Compliance with standards voltage transient limit	Full temperature range	Maximum	VDC/ms	100V/50ms
		Maximum	VDC/s	48V/1s
		MIL-STD-704A/F	80V/75ms	Compliant
		AECMA EN2282	60V/50ms	Compliant
		AIR2021E	60V/100ms	Compliant
		D0160E cat A/Z	80V/100ms	Compliant
Compliance with standards voltage spike limit *with companion filter FGDS series	50 Ohms impedance	MIL-STD-704A/F	600V/10μs	Compliant*
	50 Ohms impedance	AECMA EN2282	400V/100μs	Compliant*
	50 Ohms impedance	AIR2021E	600V/10μs	Compliant*
	50 Ohms impedance	D0160E cat A/Z	600V/10μs	Compliant*
	15 mJ energy content	MIL-STD-1275A/D	250V/70μs	Compliant*
Under voltage lock- out (UVLO)	Turn-on/Turn-off threshold	Minimum	VDC	7
		Maximum	VDC	9
Start up time	U _i nominal 28V Full load	Maximum	ms	6
Inrush current limitation	Full temperature range C=1000μF	Typical	A	5
No load input current	U _i nominal 28V No load	Maximum	mA	10
Output				
Nominal voltage in normal operation	U _i < 42V Full load	Maximum	/	U _i - 150mV
Nominal voltage in transient protection mode	In transient Input voltage range	Minimum	VDC	40
		Nominal	VDC	42
		Maximum	VDC	44
Output voltage slew rate	During start-up time	Typical	VDC/ms	5
Output current	Full temperature range U _i min. to max.	Maximum	A	20 (or 300W)
Output Power	Full temperature range U _i min. to max.	Maximum	W	see page 4 figure 5
Power dissipation	Output current 20A	Maximum	W	3

4- Electrical Characteristics (continued)

Figure 1 : LGDS-300-0-K Transient Response at 80Vdc (according to D0-160D/E/F)

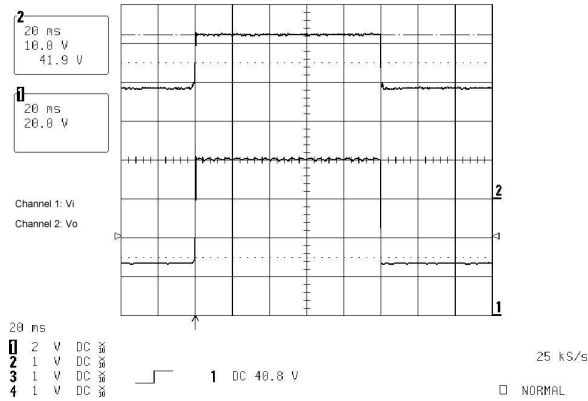

Figure 2 : LGDS-300-0-K Transient Response at 100Vdc (according to MIL-STD-1275D)

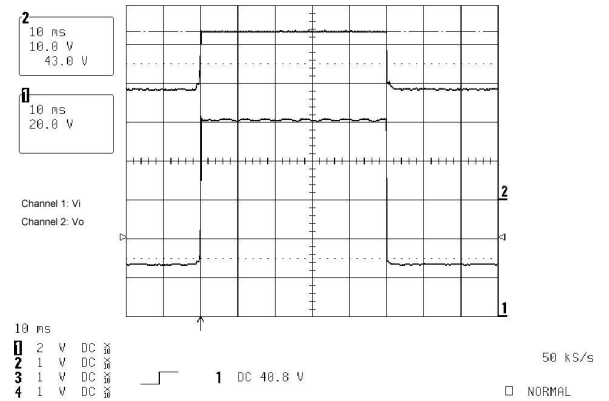

Figure 3 : LGDS-300-0-K Output Power versus Input Voltage

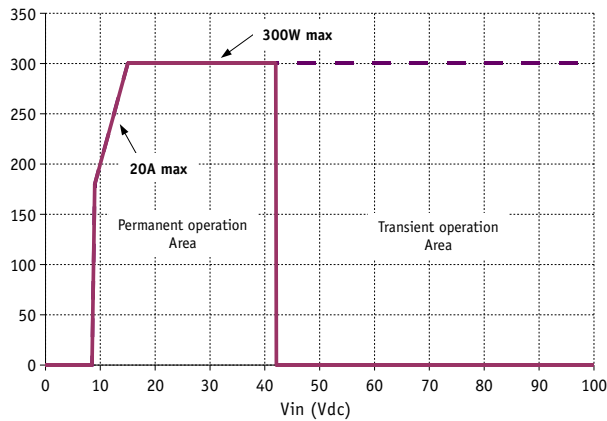
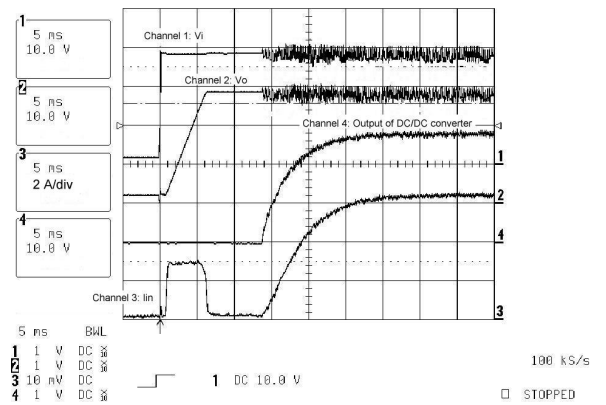
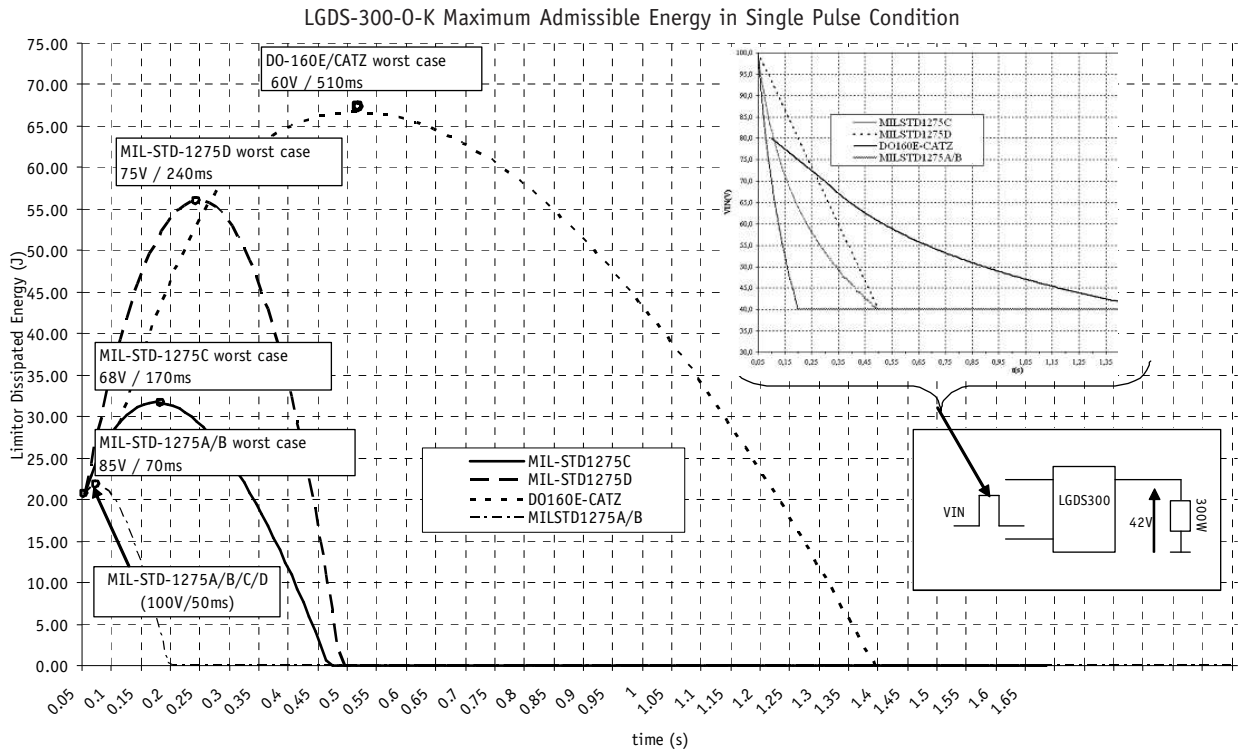

Figure 4 : LGDS-300-0-K Start-up Timing



4- Electrical Characteristics (continued)

The following figures describe the LGDS-300-0-K maximum admissible energy in compliance with standard requirements for single pulse and repetitive surge conditions.



4

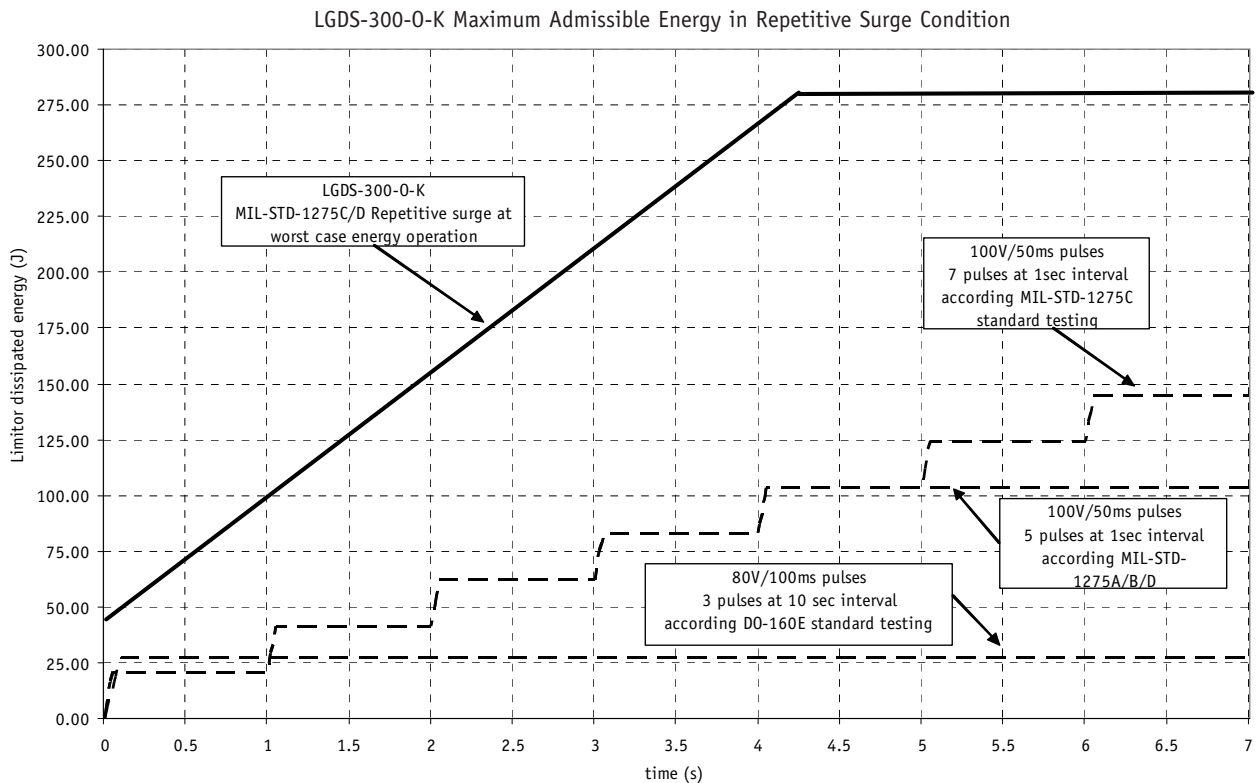

5

5- Isolation

Parameter	Conditions	Limit or typical	Specifications
Electric strength test voltage	Input to output All pins to case	/ Minimum	No isolation 500 VDC / 1 min
Isolation resistance	50 VDC, all pins to case	Minimum	100 MOhm

6- Protection Functions

Characteristics	Protection Device	Recovery	Limit or typical	Specifications
Output over current protection (OCP)	Hiccup circuitry with auto-recovery	Automatic recovery	Permanent	See section 10
Over temperature protection (OTP)	Thermal device with hysteresis cycle	Automatic recovery	Nominal	120°C

4

7- Reliability Data

Characteristics	Conditions	Temperature	Specifications
Mean Time Between Failure (MTBF) According to MIL-HDBK-217F	Ground fixed (Gf)	Case at 40°C Case at 85°C	1 300 000 Hrs 425 000 Hrs
	Airborne, Inhabited, Cargo (AIC)	Case at 40°C Case at 85°C	675 000 Hrs 250 000 Hrs
Mean Time Between Failure (MTBF) According to IEC-62380-TR	Civilian avionics, calculators	Ambient at 55°C 100% time on	1 800 000 Hrs

8- Thermal Characteristics

Characteristics	Conditions	Limit or typical	Performances
Operating ambient temperature range at full load	Ambient temperature *	Minimum Maximum	- 40°C + 85°C
Operating case temperature range at full load	Case temperature	Minimum Maximum	- 40°C +105°C
Storage temperature range	Non functioning	Minimum Maximum	- 55°C + 125°C
Thermal resistance	Rth case to ambient in free air natural convection	Typical	12°C /W

Note * : The upper temperature range depends on configuration, the user must assure a max. case temperature of + 105°C.

The LGDS-300 series operating **case** temperature at full load must not exceed 105°C. The maximum **ambient** temperature admissible for the DC/DC converter corresponding to the maximum operating case temperature of 105°C depends on the ambient airflow, the mounting/orientation, the cooling features and the power dissipated.

To calculate a maximum admissible ambient temperature the following method can be used. Knowing the maximum case temperature Tcase = 105°C of the module, the power used Pout and the efficiency η :

- determine the power dissipated by the module P_{diss} that should be evacuated :

$$P_{diss} = P_{out}(1/\eta - 1)$$

- determine the maximum ambient temperature :

$$T_a = 105^\circ\text{C} - R_{th} \times P_{diss}$$

where **Rth** is the thermal resistance from the case to ambient.

The previous thermal calculation shows two areas of operation :

- a normal operation area in a free natural ambient convection (grey area in the following graph),
- an area with cooling features (air flow or heatsink) ensuring a maximum case temperature below the maximum operating case temperature of 105°C at full load (white area in the following graph).

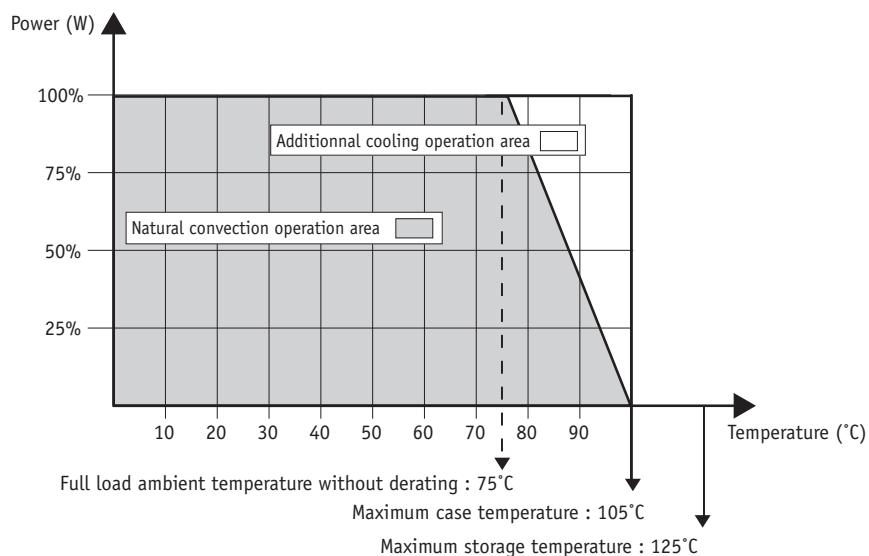

9- Environmental Qualifications

The modules have been subjected to the following environmental qualifications.

Characteristics	Conditions	Severity	Test procedure
Climatic Qualifications			
Life at high temperature	Duration Temperature / status of unit	Test D : 1 000 Hrs @ 105°C case, unit operating @ 125°C ambient, unit not operating	MIL-STD-202G Method 108A
Altitude	Altitude level C Duration Climb up Stabilization Status of unit	40 000 ft@-55°C 30 min. 1 000 ft/min to 70 000 ft@-55°C, 30 min. unit operating	MIL-STD-810E Method 500.3
Humidity cyclic	Number of cycle Cycle duration Relative humidity variation Temperature variation Status of unit	10 Cycle I : 24 Hrs 60 % to 88 % 31°C to 41°C unit not operating	MIL-STD-810E Method 507.3
Humidity steady	Damp heat Temperature Duration Status of unit	93 % relative humidity 40°C 56 days unit not operating	MIL-STD-202G Method 103B
Salt atmosphere	Temperature Concentration NaCl Duration Status of unit	35°C 5 % 48 Hrs unit not operating	MIL-STD-810E Method 509.3
Temperature cycling	Number of cycles Temperature change Transfert time Steady state time Status of unit	200 -40°C / +85°C 40 min. 20 min. unit operating	MIL-STD-202A Method 102A
Temperature shock	Number of shocks Temperature change Transfert time Steady state time Status of unit	100 -55°C / +105°C 10 sec. 20 min. unit not operating	MIL-STD-202G Method 107G
Mechanical Qualifications			
Vibration (Sinusoidal)	Number of cycles Frequency / amplitude Frequency / acceleration Duration Status of unit	10 cycles in each axis 10 to 60 Hz / 0.7 mm 60 to 2 000 Hz / 10 g 2h 30 min. per axis unit not operating	MIL-STD-810D Method 514.3
Shock (Half sinus)	Number of shocks Peak acceleration Duration Shock form Status of unit	3 shocks in each axis 100 g 6 ms 1/2 sinusoidal unit not operating	MIL-STD-810D Method 516.3
Bump (Half sinus)	Number of bumps Peak acceleration Duration Status of unit	2 000 Bumps in each axis 40 g 6 ms unit not operating	MIL-STD-810D Method 516.3

10- Description of Protections

The LGDS-300 includes 3 types of protection devices.

10-1 Output Over Current Protection (OCP)

The LGDS-300 provides a circuit breaker function that latches the output off if the load current exceeds the current limit threshold for a duration. The circuit breaker function automatically attempts to restart power after a load current fault at a low duty cycle to prevent the LGDS-300 from overheating. The over current protection function protects the module against over load of any duration and restores the module to normal operation when the over load is removed. It operates in «hiccup» mode by testing periodically if an overload is applied (typically every 1s recovery time). The overload detection threshold is typically 30A with a detection time lower than 5ms.

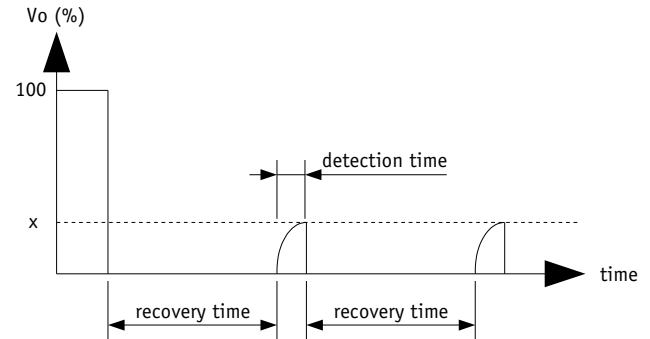

10-2 Inrush Current Limitation

The inrush current limitation function operates by limiting the output voltage ramp up. It is internally set at 5V/ms typically. The inrush current is calculated as follow.

$$I_{inrush} = C_{out} \times \frac{dV_{out}}{dt} \text{ where :}$$

- C_{out} is the capacitor value connected to the output
- $\frac{dV_{out}}{dt} = 5V/ms$

By adding a capacitor connected across the pins «Drive» & «Gi», and in order to reduce the inrush current the value $\frac{dV_{out}}{dt}$ can be adjusted as follow :

$$\frac{dV_{out}}{dt} = \frac{50}{10 + C_{DRIVE}} \text{ V/ms} \quad C_{DRIVE} \text{ is given in nF}$$

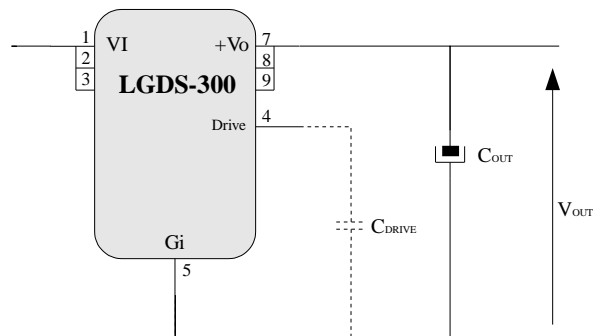
4

10-3 Over Temperature Protection (OTP)

A thermal protection device adjusted at 120°C (+/-5%) internal temperature with a 10°C hysteresis cycle will inhibit the module as long as the overheat is present and restores to normal operation automatically when overheat is removed.

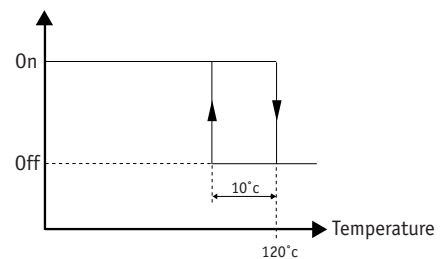

11- Application Notes

11-1 Reverse Polarity Compatibility

The LGDS-300 has been designed to be compliant with reverse polarity requirements. The reverse polarity protection can be externally achieved either by a standard solution using a schottky diode or either a low losses solution using a N channel power MOSFET. The following figures are showing both solutions.

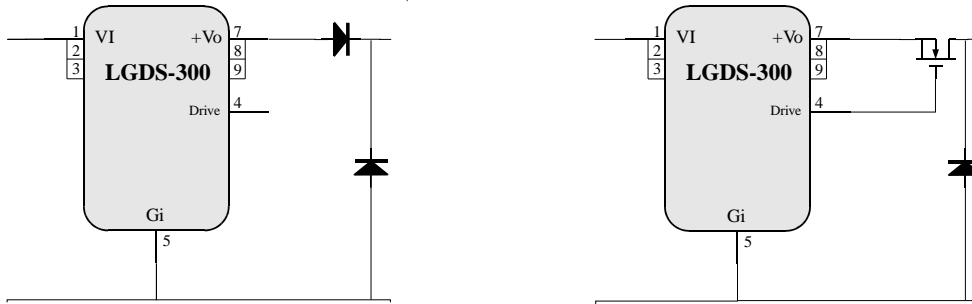

11-2 Drive Function

The LGDS-300 features a drive function used to adjust the inrush current limit during start-up phase and to achieve a low loss reverse polarity protection.

Parameter	Unit	Min.	Typ.	Max.	Notes, conditions
Drive voltage	Vdc	Vo-0.6	/	Vo+12	
Drive current					
source	μA	50	/	100	Must be externally limited
sink	μA	-1000	/	0	

4

11-5 Typical Architecture Schematics Using LGDS-300 with Multiple Modules

The LGDS-300 is compliant for use with several DC/DC GAIA converter modules in various configurations. To meet MIL-STD-461D/E/F, DO-160D/E/F requirements, GAIA Converter recommends the use of ready-to-use EMI filter together with its R*C* cell (see EMI filter datasheet for details). For stability purpose GAIA Converter recommends the use of a 220μF/50V capacitor after the LGDS-300.

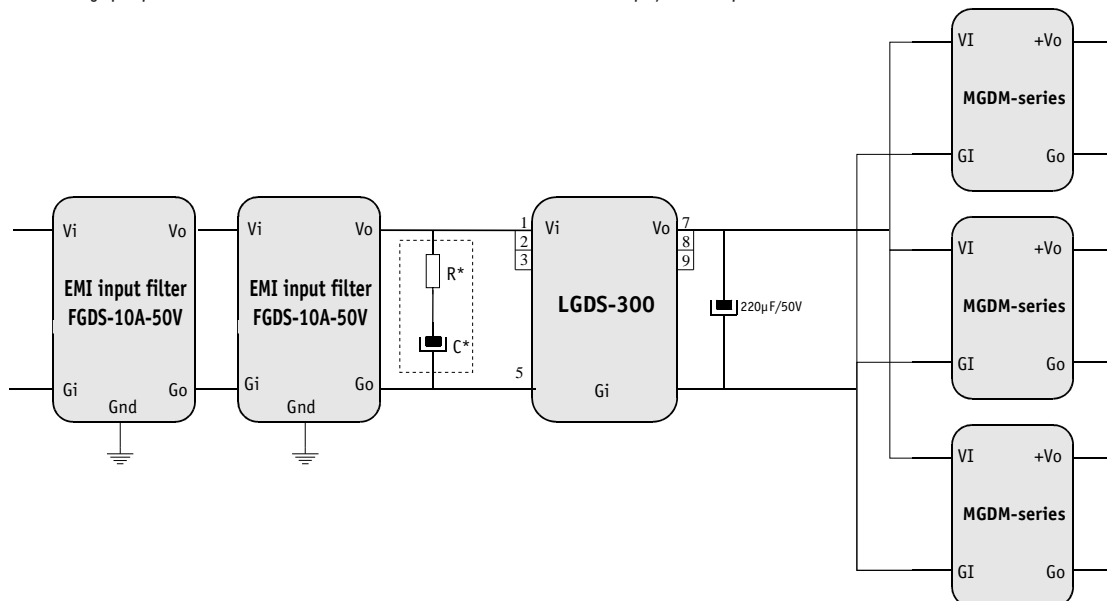

Note : such design with joint EMI filter is incompatible with reverse polarity compatibility. In such case place the second EMI filter after LGDS-300.

12- Dimensions

Dimension are given in mm. Tolerance : +/- 0,2 mm unless otherwise indicated.
Weight : 35 grams (1.22 Ozs) max.

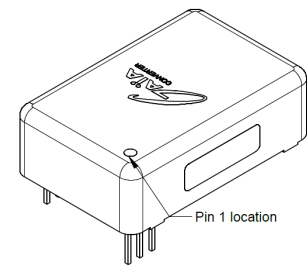
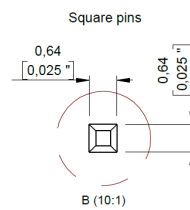
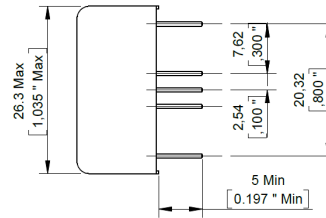
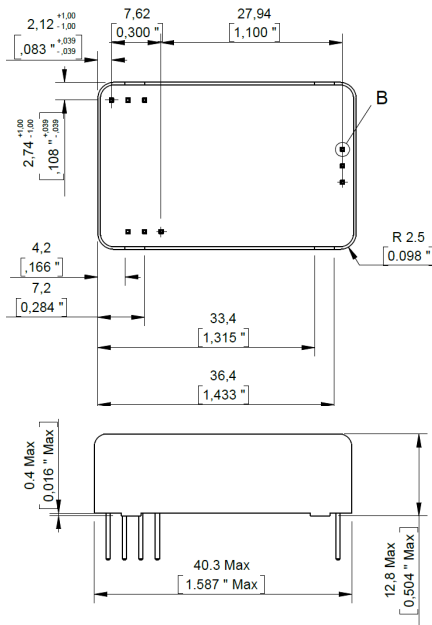

13- Materials

Case : Metallic black anodized coating.
Pins : Plated with pure matte tin over nickel underplate.

14- Product Marking

Upper face : Company logo.
Side face : Module reference, option, date code : year and week of manufacturing.

15- Connections

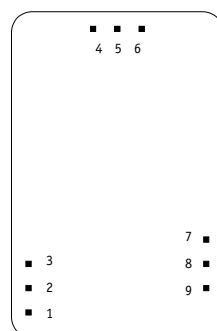

Bottom view

Pin	LGDS-300
1,2,3	+Input (Vin)
4	Drive
5	Common (Gin)
6	Not connected
7,8,9	Output (Vo)



For more detailed specifications and applications information, contact :

International Headquarters

GAIA Converter - France
18 Rue Caroline Aigle
33186 LE HAILLAN - FRANCE
Tel. : + (33)-5-57-92-12-80
Fax : + (33)-5-57-92-12-89

North American Headquarters

GAIA Converter-Canada, INC
1405 Transcanada Hwy, Suite 520
DORVAL, QUEBEC, H9P 2V9
Tel. : (514)-333-3169
Fax : (514)-333-4519

Represented by :