



MIL-STD-461 EMI INPUT FILTER FGDS-6A-100V : up to 6A CURRENT

Hi-Rel
Grade ■■

6A EMI Filter Module 4.5 to 100 VDC Input Range MIL-STD-461D/E/F/G & DO-160C/D/E/F/G Compliant



• To comply with MIL-STD-461D/E/F/G power leads :

- CE 102 : Emission requirement over 10 KHz to 10MHz
- CS 101 : Susceptibility requirement over 30Hz to 150KHz
- CS 114 : Susceptibility requirement over 10KHz to 400MHz
- CS 115 : Susceptibility requirement for spikes

• To comply with DO-160C/D/E/F/G power lines :

- Conducted emission requirement over 15 KHz to 152MHz
- Conducted susceptibility requirement over 10Hz to 400MHz

• Temperature range :

- operating temperature : -40°C/+105°C case
- storage temperature : -55°C/+125°C

• RoHS process

1-General

The GAIA Converter filter module FGDS-6A-100V provides a state-of-the-art product to fulfill Electromagnetic Interferences (EMI) requirements for Aerospace and Defence applications.

The FGDS-6A-100V is a very compact and low loss solution for applications requiring up to 6A input current. It embeds circuit that avoid internal capacitor to cause inrush current at start-up.

The FGDS-6A-100V is suitable for MGDD series DC/DC converters and DC architecture

- from 10W up to 160W output power
- up to 6A output current
- up to 100V permanent input voltage.

The FGDS-6A-100V is the ideal companion to the GAIA Converter MGDD series.

The FGDS-6A-100V complies with major standards including :

- the US MIL-STD-461 rev D, E, F and rev G
- the international DO-160 rev C, D, E, F & rev G.

In addition, thanks to its 100V permanent capability, the filter complies with:

- MIL-STD-704A/D/E/F with up to 80V/100ms
- MIL-STD-1275A/B/C/D with up to 100V/50ms

In particular, the filter module is compliant with the following requirements of MIL-STD-461D/E/F/G and DO-160-C/D/E/F/G standards :

• MIL-STD-461D/E/F Part 2. & 3. requirements :

- **Conducted Emission (CE)**
 - CE102, power leads, emission over 10KHz to 10MHz, basic curve
- **Conducted Susceptibility (CS)**
 - CS101, power leads, frequency 30Hz to 150KHz, curve #1,
 - CS114, bulk cable injection, frequency 10KHz to 400MHz,
 - CS115, spikes, bulk cable injection calibrated spike
 - CS116, damped sinusoidal transient

• DO-160-C/D/E/F/G requirements :

- **Conducted Emission (CE)**
 - Section 21 power lines, emission over 15KHz to 152MHz, category B, AZ & LMH
- **Conducted Susceptibility (CS)**
 - Section 20 power lines, frequency 10KHz to 400MHz

6

2-Product Selection

FGDS-6A-100V / option

Options :

- /T : option for -55°C start up operating temperature
- /S : option for screening and serialization

3- Electrical Specifications

Data are valid at +25°C, unless otherwise specified.

Parameter	Conditions	Limit or typical	Units	FGDS-6A-100V
Input				
Nominal input voltage	Full temperature range	Nominal	VDC	28
Permanent input voltage range (Ui)	Full temperature range	Min. - Max.	VDC	4.5- 100
Output				
Permanent output current (I)	Full temperature range up to 105°C case Ui min. to max.	Maximum	A	6
Permanent output power	Full temperature range up to 105°C case Ui = 28Vdc.	Maximum	W	160
Power dissipation	Current 6A	Typical	W	1.08
		Maximum	W	1.26
DC resistance	Current 6A 25°C case	Typical	mOhm	30
		Maximum	mOhm	35
DC resistance	Current 6A 105°C case	Maximum	mOhm	42
Thermal resistance (Rth)	Case to ambient in free air cooling	Nominal	°C/W	20
General				
Electrical strength test voltage	Case to any pin Gnd pin to any other pin	Minimum	VDC	500
		Minimum	VDC	500
Reliability data MTBF according MIL-HDBK-217F	Conditions GB	@40°C	Hours	8 200 000
	Conditions Gf	@40°C	Hours	1 740 000
		@70°C	Hours	950 000
Conditions AIC	@40°C	Hours	960 000	
	@85°C	Hours	390 000	
EMI compliance				
Conducted emission	Power leads	MIL-STD-461D/E/F	CE102	See section 6
	Power lines	DO-160C cat B & AZ	Section 21	See section 6
	Power lines	DO-160D/E/F/G cat B & LMH	Section 21	See section 6
Conducted susceptibility	50 Ohm impedance Imax = 6A 10KHz to 400MHz	MIL-STD-461D/E/F	CS115	Compliant
		MIL-STD-461D/E/F	CS116	Compliant
		DO-160C/D/E/F/G	Section 20	Compliant

4- EMI Filter Electrical Schematics

Designed specifically for GAIA Converter MGDD series, the GAIA Converter FGDS-6A-100V is suitable:

- from 10W up to 160W total output power and up to 6A output current
- up to 100V permanent input voltage .

4-1 Thermal Management

Important notice : The GAIA Converter FGDS-6-100V being compact, it might require cooling depending on current expected to flow. It is necessary to evaluate the dissipated power (Pd) to determine if operating case temperature Tc is within the specification. please refer to the formula below :

Rth = Case to Ambient thermal resistance

Pd = (DC resistance) x (I)²

Tc = Ambient temperature + (Pd) x (Rth)

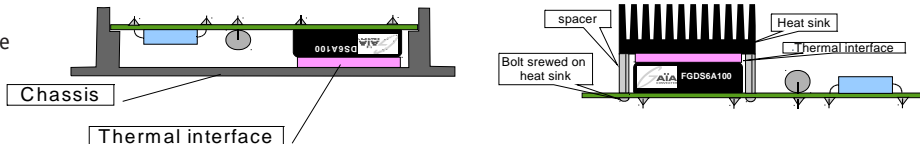

4-2 EMI Filter Electrical Schematics With MGDD serie DC/DC converter

The GAIA Converter FGDS-6A-100V is particularly suitable to be used as front-end architecture of MGDD series converter.

Below are presented typical schematics.

Capacitor C1 is not mandatory, but can be used to improve stability and EMI performances in specific cases (low input voltage, high power, stringent EMI requirements, use of multiple DC/DC converters.) capacitors Ccm are common mode capacitors, refer to the corresponding MGDD datasheet for recommended Ccm values.

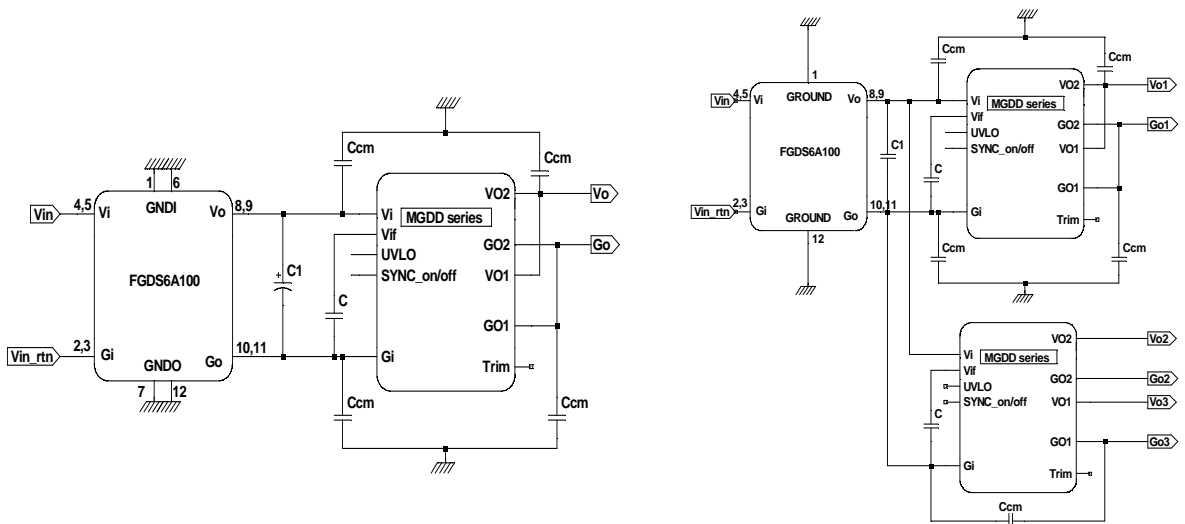

4-3 EMI Filter Current Surge Limitation

The FGDS-6A-100V embeds a current surge limitation circuit that prevents internal capacitors to generate inrush current when DC input is applied. Though the noise filtering function is fully passive, the FGDS-6A-100V contains a MOSFET transistor performing current surge limitation function.

The filter must be connected with direct polarity to enable this function. If the filter is connected with reverse polarity, the filtering function will be degraded, while the filter will not be damaged.

4-4 EMI Filter GNDI & GNDO Considerations

The GAIA Converter FGDS-6A-100V has 2 ground-in (GNDI) pins and 2 ground-out (GNDO) pins that are internally connected respectively to input common mode noise suppressor and output common mode noise suppressor. Those 4 pins need to be connected to power plane tied to chassis as common mode signal reference.

If the application does not provide any chassis connection access, GNDI and GNDO need to be connected to DC/DC input connection GI.

4- EMI Filter Electrical Schematics (continued)

4-5 C1 Capacitance Discussion

The C1 damping capacitor is used for stability purposes. DC/DC converters are not resistive loads, and their input impedance ($Z_{in} = V_{in}/I_{in}$) variation follows a curve with negative slope.

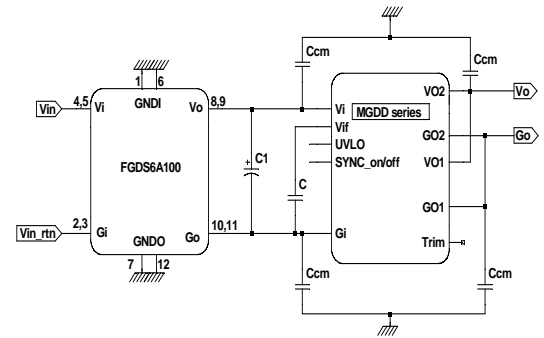
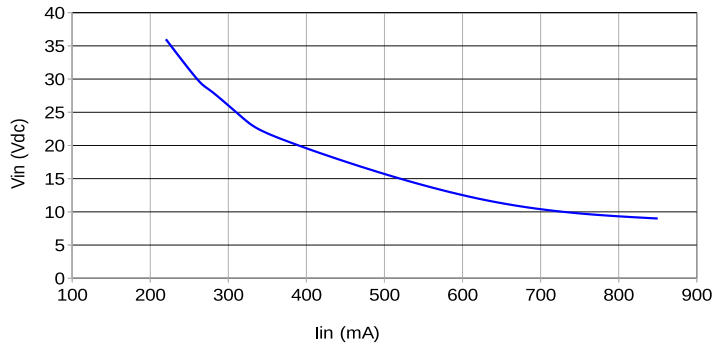

In some cases, for low input voltage or high input current the output impedance of filter might be higher than DC/DC input impedance and lead to filter oscillation. To ensure the stability of the whole system "LISN + input Filter + DC/DC converters", the filter output impedance must be kept below the converter's input impedance. this condition can be achieved by tuning the C1 capacitor value.

The values of C1 (RCnetwork if we consider the C1 ESR) has to be adjusted to dampen sufficiently the filter resonance and make its output impedance lower than the converter input impedance. The value of C1 strongly depends on the application conditions (input voltage range and total power drawn from the source as well as the standards that the equipment has to meet MIL-STD-461 or DO-160 ...) this because measurements method (LISN) differs from one standard to another affecting the C value.

In most applications a low ESR aluminium electrolytic capacitor can be used for damping the network and it's **internal ESR value will be enough to dampen the input voltage without adding external resistor.**

The table hereafter summarizes the recommended minimum capacitor value for various power levels according to DO-160 and to MIL-STD-461 standards.

Total Power	8W	20W	40W	80W	150W
Capacitor Value for MIL-STD-461 standards	not required	not required	47 μ F	47 μ F	100 μ F
Capacitor Value for DO-160 standards	not required	not required	not required	33 μ F	68 μ F

5- MIL-STD-461D/E/F/G Conducted Emission Tests Set-Up

5-1 MIL-STD-461D/E/FG Measurement Method

The conducted noise emission measurement method is described in the MIL-STD-461D/E/F/G standards. The «DUT» (Device Under Test) is powered through a 2 meters power cable.

One end is terminated with the DUT and the other end is terminated with LISN networks. The measurements are made with a measurement receiver, (spectrum analyser) that measure voltage in dB μ V

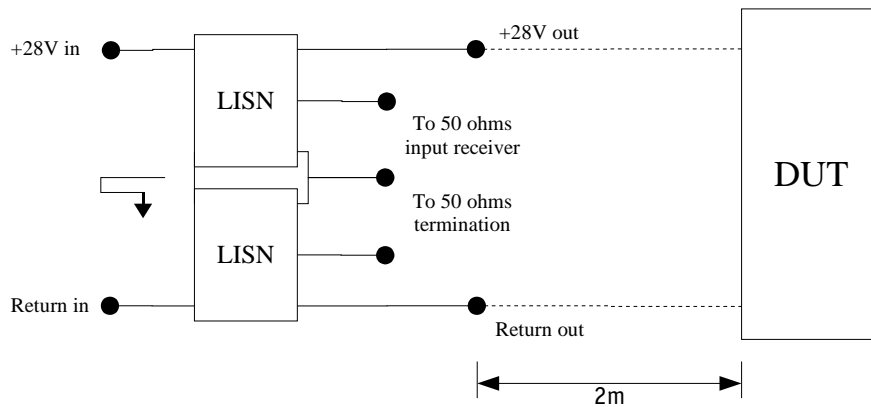

5-1 D0-160 Measurement Method

The conducted noise emission measurement method is described in the D0-160 standards. The «DUT» (Device Under Test) is powered through power cables.

One end is terminated with the DUT and the other end is terminated with LISN networks. The measurements are performed through current probe (current transformer) connected to a spectrum analyser that measure current in dB μ A

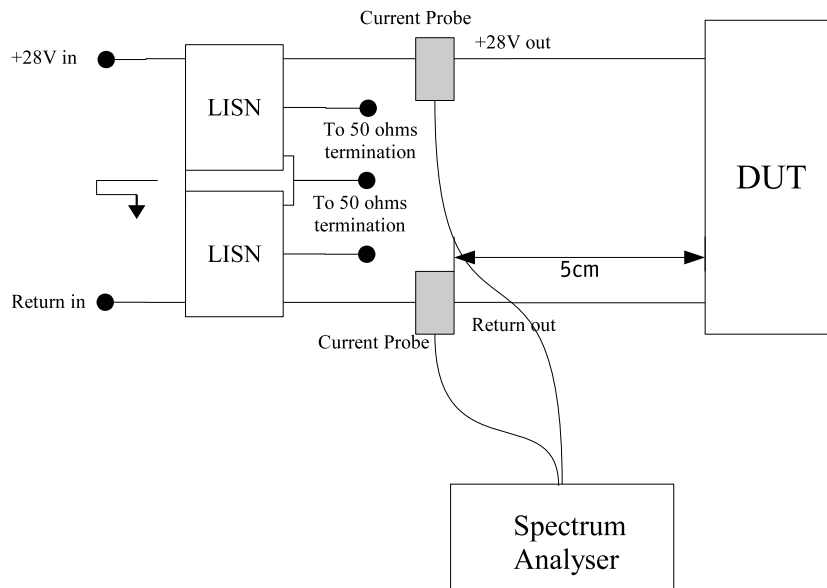

6- MIL-STD-461G Conducted Emission Level Results

MIL-STD-461G : FGDS-6A-100V and MGDD-08

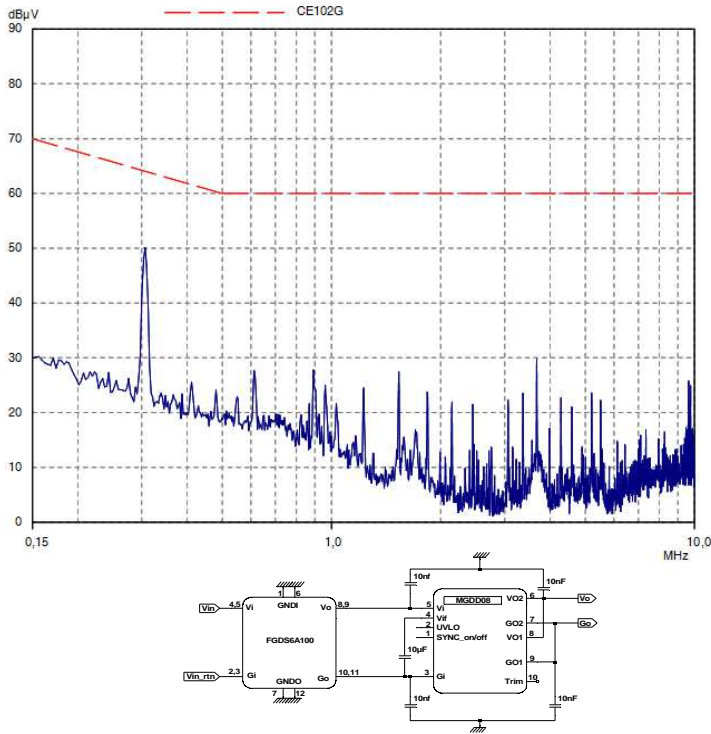

MIL-STD-461G : FGDS-6A-100V and MGDD-21

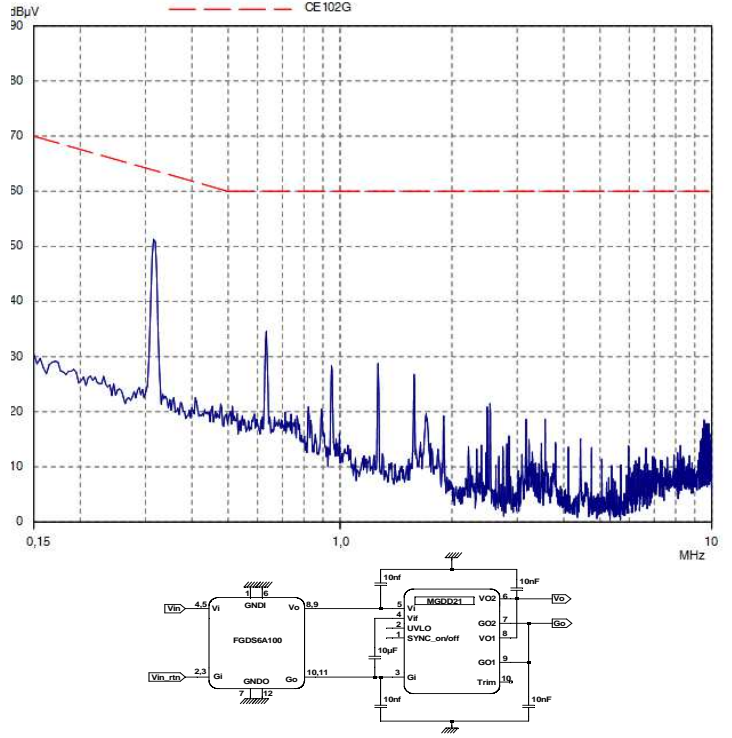

MIL-STD-461G : FGDS-6A-100V and MGDD-40

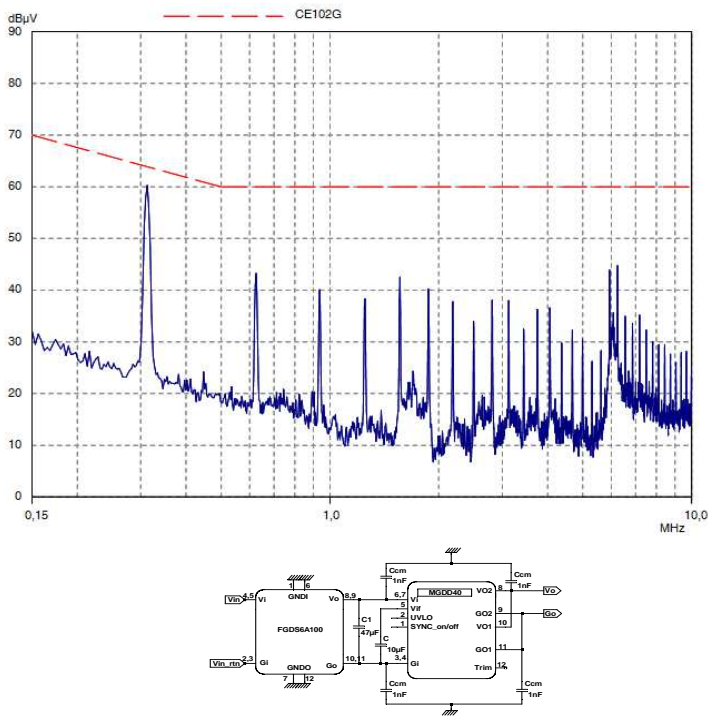

MIL-STD-461G : 2xFGDS-6A-100V and MGDD-40

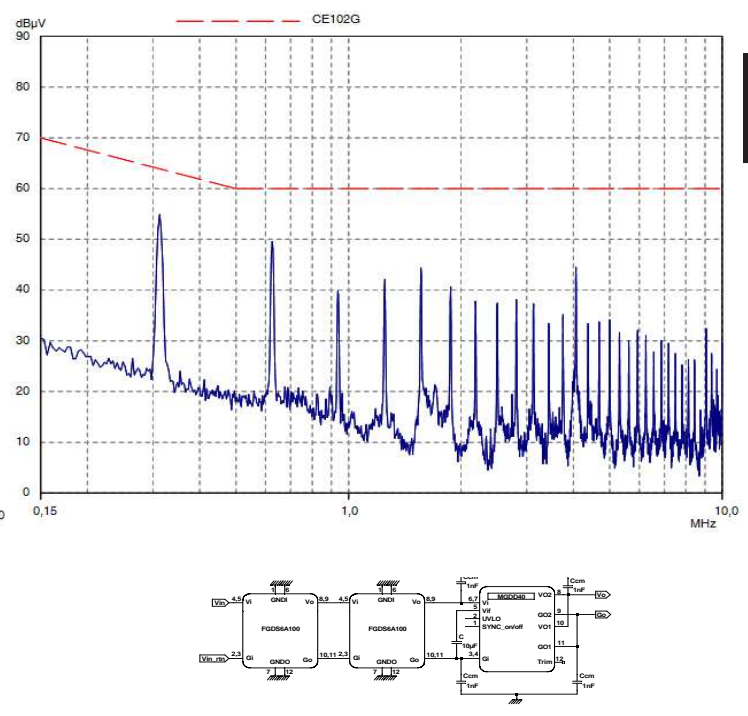

6- D0-160G Conducted Emission Level Results

D0-160G : FGDS-6A-100V and MGDD-08

D0-160G : FGDS-6A-100V and MGDD-21

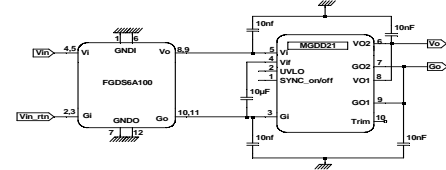
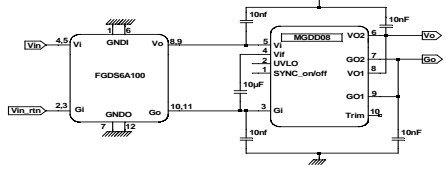
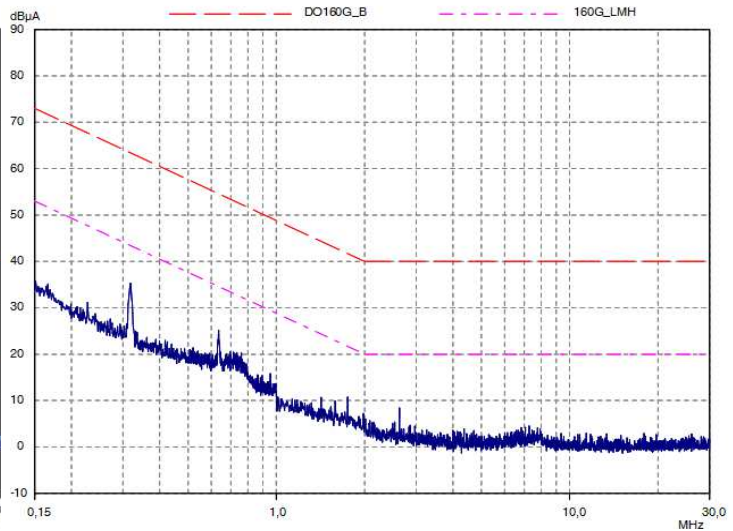
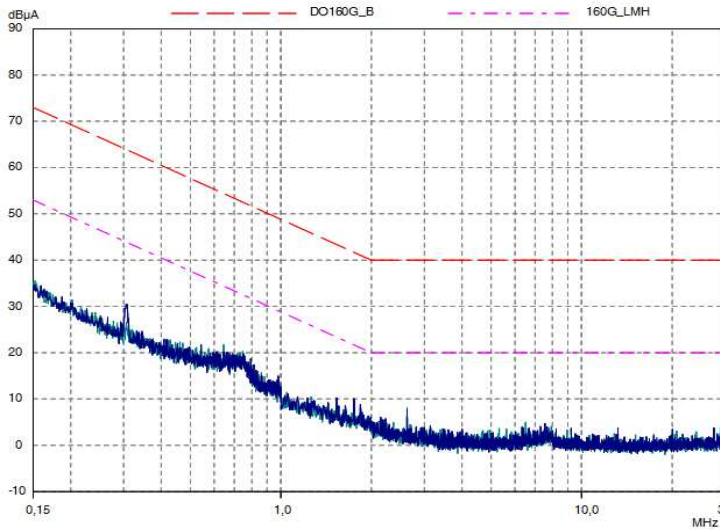

D0-160G : FGDS-6A-100V and MGDD-40

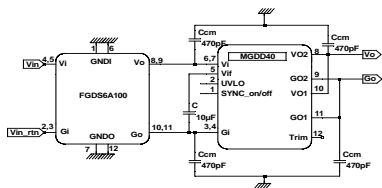
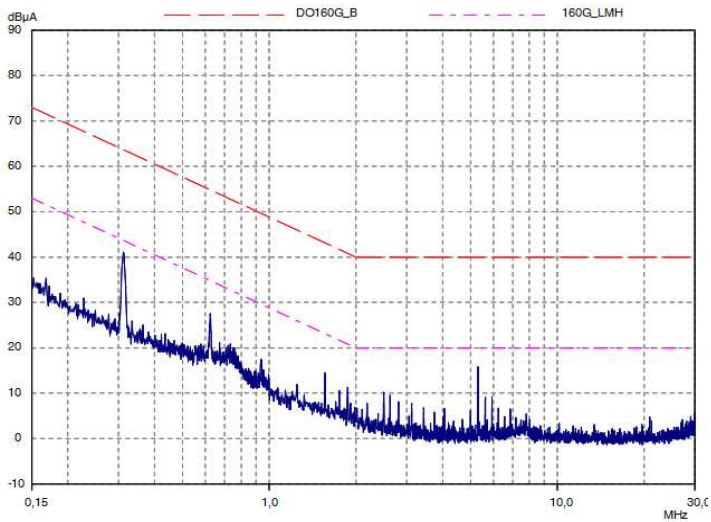

7- Environmental Qualifications

The modules have been subjected to the following environmental qualifications.

Characteristics	Conditions	Severity	Test procedure
Climatic Qualifications			
Life at high temperature	Duration Temperature / status of unit	Test D : 1 000 Hrs @ 105°C case, unit operating @ 125°C ambient, unit not operating	MIL-STD-202G Method 108A
Altitude	Altitude level C Duration Climb up Stabilization Status of unit	40 000 ft@-55°C 30 min. 1 000 ft/min to 70 000 ft@-55°C, 30 min. unit operating	MIL-STD-810E Method 500.3
Humidity cyclic	Number of cycle Cycle duration Relative humidity variation Temperature variation Status of unit	10 Cycle I : 24 Hrs 60 % to 88 % 31°C to 41°C unit not operating	MIL-STD-810E Method 507.3
Humidity steady	Damp heat Temperature Duration Status of unit	93 % relative humidity 40°C 56 days unit not operating	MIL-STD-202G Method 103B
Salt atmosphere	Temperature Concentration NaCl Duration Status of unit	35°C 5 % 48 Hrs unit not operating	MIL-STD-810E Method 509.3
Temperature cycling	Number of cycles Temperature change Transfert time Steady state time Status of unit	200 -40°C / +85°C 40 min. 20 min. unit operating	MIL-STD-202A Method 102A
Temperature shock	Number of shocks Temperature change Transfert time Steady state time Status of unit	100 -55°C / +105°C 10 sec. 20 min. unit not operating	MIL-STD-202G Method 107G
Mechanical Qualifications			
Vibration (Sinusoidal)	Number of cycles Frequency / amplitude Frequency / acceleration Duration Status of unit	10 cycles in each axis 10 to 60 Hz / 0.7 mm 60 to 2 000 Hz / 10 g 2h 30 min. per axis unit not operating	MIL-STD-810D Method 514.3
Shock (Half sinus)	Number of shocks Peak acceleration Duration Shock form Status of unit	3 shocks in each axis 100 g 6 ms 1/2 sinusoidal unit not operating	MIL-STD-810D Method 516.3
Bump (Half sinus)	Number of bumps Peak acceleration Duration Status of unit	2 000 bumps in each axis 40 g 6 ms unit not operating	MIL-STD-810D Method 516.3

8- Dimensions

Dimension are given in mm (inches). Tolerance : +/- 0,2 mm (+/-0.01") unless otherwise indicated.
Weight : 25 grams (0.882 Ozs) max.

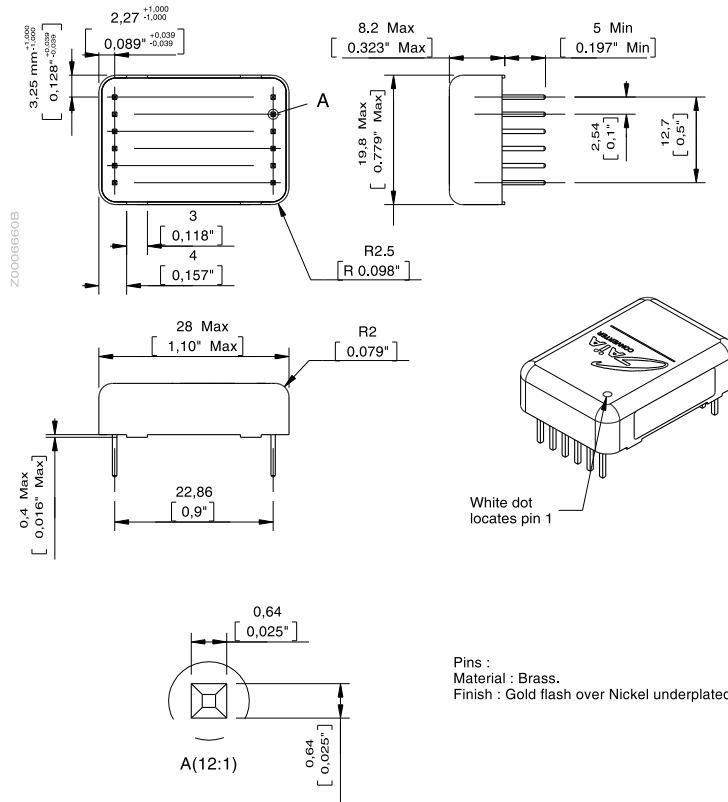

9- Materials & Product Marking

Case : Metallic case black anodized coating.
Top face : Company logo.
Side : Module reference, option, date code : year and week of manufacturing.

10- Connections

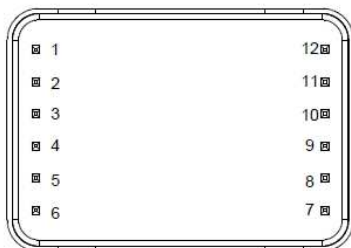

Bottom view

Pin	Single
1	GNDI
2, 3	GI
4, 5	VI
6	GNDI
7	GND0
8, 9	VO
10, 11	GO
12	GND0



For more detailed specifications and applications information, contact :

International Headquarters

GAIA Converter - France
18 Rue Caroline Aigle
33186 LE HAILLAN - FRANCE
Tel. : + (33)-5-57-92-12-80
Fax : + (33)-5-57-92-12-89

North American Headquarters

GAIA Converter Canada, Inc
1405 Transcanada Hwy, Suite 520
DORVAL, QUEBEC, H9P 2V9
Tel. : (514)-333-3169
Fax : (514)-333-4519

Represented by :

Information given in this datasheet is believed to be accurate and reliable. However, no responsibility is assumed for the consequence of its use nor for any infringement of patents or other rights of third parties which may result from its use. These products are sold only according to GAIA Converter general conditions of sale, unless otherwise confirmed by writing. Specifications subject to change without notice.